

# SITE PLAN MODIFICATION OF 505 WEST CENTRAL STREET, LOT 3 (515 WEST CENTRAL STREET) FRANKLIN MASSACHUSETTS

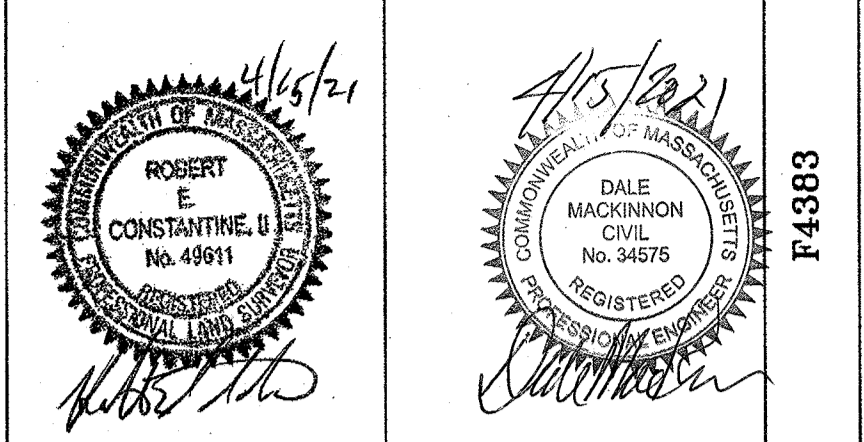

APPROVED DATE: \_\_\_\_\_  
FRANKLIN PLANNING BOARD  
\_\_\_\_\_  
\_\_\_\_\_  
\_\_\_\_\_  
\_\_\_\_\_  
BEING A MAJORITY

## INDEX

1. COVER SHEET
  2. EXISTING CONDITIONS
  3. EROSION CONTROL PLAN
  4. SITE PLAN
  - 4A. FIRE TRUCK RADIUS
  5. GRADING & UTILITY PLAN
  6. LANDSCAPING PLAN
  7. PHOTOMETRIC PLAN
  8. CONSTRUCTION DETAILS
  9. CONSTRUCTION DETAILS
  10. CONSTRUCTION DETAILS
- ARCHITECTURAL PLANS**
- 1.1 SCHEMATIC FLOOR PLANS
  - 1.2 ELEVATIONS
  - 1.3 SIGNAGE
  - 1.4 RENDERING
- SUPPLEMENTAL INFORMATION**
- A. APPROVED PRIVATE DEFINITIVE SUBDIVISION LOTTING PLAN SITE PLAN
  - B. SITE PLAN FOR 505 WEST CENTRAL STREET COVER SHEET PROPOSED SITE CONDITIONS
  - C. SITE AS-BUILT WENDY'S RESTAURANT
  - D. LIMITED SITE PLAN MODIFICATION & INTERIM AS-BUILT LOT 1 529 WEST CENTRAL STREET FOR MIDAS AUTO SERVICE & TIRES

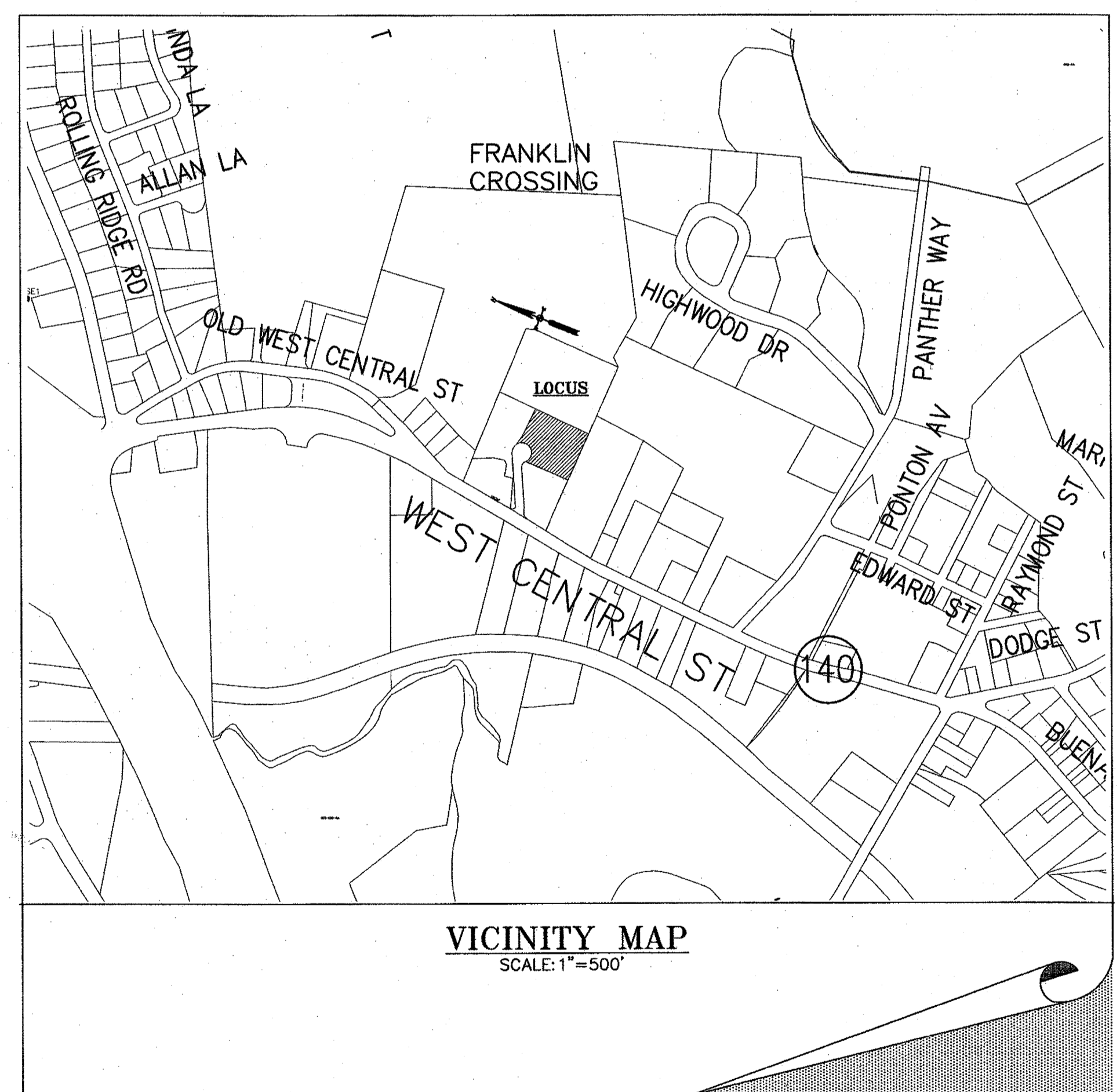

## SPECIAL NOTES:

1. SEE SITE PLAN APPROVED BY THE FRANKLIN PLANNING BOARD ON APRIL 11, 2011 BY GUERRIERE AND HALNON, INC. ENTITLED 'SITE PLAN FOR 505 WEST CENTRAL STREET IN FRANKLIN MASSACHUSETTS'
2. SEE SITE PLAN APPROVED BY THE FRANKLIN PLANNING BOARD ON AUGUST 10, 2011 BY GUERRIERE AND HALNON, INC. ENTITLED 'LIMITED SITE PLAN MODIFICATION FOR 505 WEST CENTRAL STREET IN THE TOWN OF FRANKLIN, MASSACHUSETTS'
3. SEE PLAN APPROVED BY THE FRANKLIN PLANNING BOARD ON SEPTEMBER 25, 2013 BY GUERRIERE AND HALNON, INC. ENTITLED 'PRIVATE DEFINITIVE SUBDIVISION 505 WEST CENTRAL STREET FRANKLIN MASSACHUSETTS'
4. SEE PLAN ENTITLED 'SITE AS-BUILT WENDY'S RESTAURANT 505 WEST CENTRAL STREET FRANKLIN, MASSACHUSETTS' DATED OCTOBER 25, 2012 BY GUERRIERE AND HALNON, INC.
5. SEE PLAN ENTITLED 'LIMITED SITE PLAN MODIFICATION & INTERIM AS-BUILT LOT 1 529 WEST CENTRAL STREET FOR MIDAS AUTO SERVICE & TIRES IN FRANKLIN, MASSACHUSETTS' DATED JANUARY 12, 2016 REVISED TO FEBRUARY 23, 2016 BY GUERRIERE AND HALNON, INC.

## PARKING NOTE:

1. REQUEST FOR DETERMINATION OF PARKING FROM THE PLANNING BOARD SECTION 185-21(A)(4) TO DETERMINE PARKING USING TEACHER AND VISITOR CAPACITY.

LEGAL NOTES

UTILITIES ARE PLOTTED AS A COMPILATION OF RECORD DOCUMENT MARKINGS AND OTHER OBSERVED EVIDENCE TO DEVELOP A VIEW OF THE UNDERGROUND UTILITIES AND SHOULD BE CONSIDERED APPROXIMATE. PRIOR TO EXCAVATION, THE EXACT LOCATION OF UNDERGROUND FEATURES CANNOT BE ACCURATELY, COMPLETELY AND RELIABLY DEPICTED. ADDITIONAL UTILITIES, NOT EVIDENCED BY RECORD DOCUMENTS OR OBSERVED PHYSICAL EVIDENCE, MAY EXIST. CONTRACTORS (IN ACCORDANCE WITH MASS.G.S. CHAPTER 82 SECTION 40 AS AMENDED) MUST CONTACT ALL UTILITY COMPANIES BEFORE EXCAVATING AND DRILLING AND CALL DIGSAFE AT 1(888)DIG-SAFE(72333).

CONSTRUCTION ON THIS LAND IS SUBJECT TO ANY EASEMENTS, RIGHTS-OF-WAY, RESTRICTIONS, RESERVATIONS, OR OTHER LIMITATIONS WHICH MAY BE REVEALED BY AN EXAMINATION OF THE TITLE.

**OWNER**

NORFOLK COUNTY DEVELOPMENT LLC  
185 QUINCY SHORE DRIVE, #26  
QUINCY, MA 02171

DEED BOOK 33300 PAGE 92  
PLAN NO. 40 OF 2014 PLAN BK. 628  
A.M. 270 LOT 29.2

**APPLICANT**

FRANKLIN LEARNING RE LLC.  
ATTN: MANOJ GANDHI  
208 GREAT ROAD  
LITTLETON, MA. 01460

**SITE PLAN MODIFICATION  
505 WEST CENTRAL STREET  
LOT 3  
(515 WEST CENTRAL STREET)  
FRANKLIN  
MASSACHUSETTS**

**COVER**

**OCTOBER 21, 2020**

DATE	REVISION DESCRIPTION
12/22/2020	PER TOWN COMMENTS
4/8/21	PER TOWN COMMENTS & REQUESTS
4/15/21	REVISED PARKING LAYOUT

**Guerriere & Halnon, Inc.**  
ENGINEERING & LAND SURVEYING  
55 WEST CENTRAL ST. PH. (508) 528-3221  
FRANKLIN, MA 02038 FX. (508) 528-7921  
www.gandhengineering.com

S:\ACD\From\In\F4383\DWG\F4383-B.rvt 4/15/2021 9:34:45 AM DIB

**NOTES**

1. THIS LAND IS ZONED COMMERCIAL II.
2. THE WETLANDS WERE FLAGGED BY GODDARD CONSULTING LLC. AUGUST 2020 AND FIELD LOCATED BY GUERRIERE AND HALNON, INC.
3. THE CONTRACTOR SHALL VERIFY THE LOCATION OF ALL UTILITIES IN THE FIELD. ANY DISCREPANCY WITH THE PLANS SHOULD BE REPORTED TO THE DESIGN ENGINEER UPON DISCOVERY.
4. REFER TO FRANKLIN ASSESSORS MAP 270 LOT 29.2.
5. ALL REFERENCED DEEDS ARE ON RECORD AT THE NORFOLK REGISTRY OF DEEDS.
6. THIS SITE IS NOT LOCATED WITHIN A NATURAL HERITAGE AND ENDANGERED SPECIES PROGRAM AREA.
7. ELEVATIONS ARE BASED ON HORIZONTAL DATUM:NAD83; VERTICAL DATUM: NAVD88.
8. A PRE-CONSTRUCTION MEETING WITH DPW IS REQUIRED
9. ALL SIGNAGE AND STRIPING TO CONFORM TO 'THE MANUAL FOR UNIFORM TRAFFIC CONTROL DEVICES'.
10. THE ARCHITECT WILL PROVIDE PLANS AND CALCULATIONS FOR FIRE PROTECTION IF REQUIRED.
11. ALL EROSION CONTROL DEVICES SHALL BE IN PLACE PRIOR TO CONSTRUCTION.
12. THE OWNER/APPLICANT SHALL LIMIT CONSTRUCTION DEBRIS AND MATERIALS ON THE SITE. IN THE EVENT THAT DEBRIS IS CARRIED OUT ONTO THE PUBLIC WAY, THE OWNER/APPLICANT SHALL BE RESPONSIBLE FOR ALL CLEANUP OF THE ROADWAY.

ZONING AT THE TIME OF SITE PLAN APPROVAL APRIL 11, 2011

FRONT	40'
SIDE	20'
REAR	30'

**COMMERCIAL II**

FRANKLIN ZONING BYLAW SECTION 185 ATTACHMENT 9; LAST AMENDED 03-13-2019 BY AMENDMENT 19-831

REQUIRED	40,000 SF
MINIMUM LOT AREA	175'
MINIMUM LOT FRONTAGE	200'
MINIMUM LOT DEPTH	157.5'
MINIMUM LOT WIDTH	
MINIMUM YARDS	
FRONT	40'
SIDE	30'
REAR	30'
BUILDING HEIGHT	
STORIES	3 <sup>15</sup>
FEET	40' <sup>15</sup>
% OF LOT UPLAND COVERED BY:	
STRUCTURES	70
STRUCTURES+PAVING	80

<sup>15</sup> BUILDINGS UP TO 50 FEET IN HEIGHT, REGARDLESS OF THE NUMBER OF STORIES, MAY BE PERMITTED BY A SPECIAL PERMIT FROM THE PLANNING BOARD

**LEGEND**

⊠	CATCH BASIN	☆	LIGHT POLE
⊙	DRAIN MANHOLE	⊙	UTILITY POLE
⊕	ELECTRIC MANHOLE	•	GUY WIRE
⊗	SEWER MANHOLE	—	SIGN
○	MANHOLE	•	WETFLAG
⊕	GAS VALVE	⊙	UTILITY POLE
⊕	GAS SHUT OFF VALVE	⊕	PROP. PARKING LIGHTING
⊕	WATER VALVE	⊕	PROP. SECURITY LIGHTING
⊕	WATER SHUT OFF VALVE	x 000.0	SPOT ELEVATION
⊕	FIRE HYDRANT	⊕	RIPRAP
— 000 —	EXISTING CONTOUR		
— D —	EXISTING DRAIN LINE		
— W —	EXISTING WATER LINE		

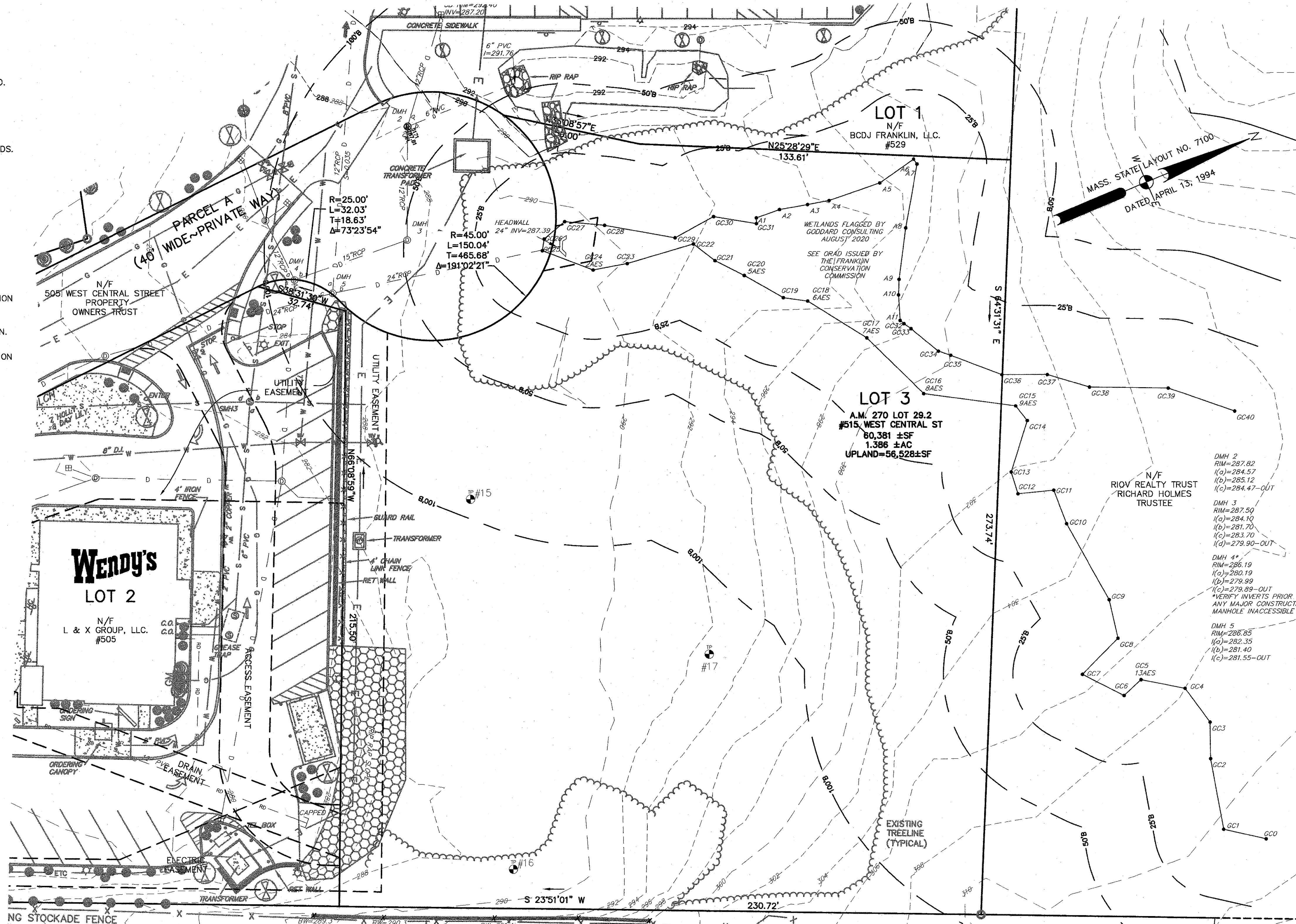

TEST PITS WERE PERFORMED ON 10/4/2010 AND WERE PART OF THE ORIGINAL SITE PLAN APPROVED ON APRIL 11, 2011

288.2 DTH #15

PAVEMENT	2"
GRAVEL	20"
LOAMY SAND	89"
SILT	

SEEPAGE @ 101" ELEV=279.78  
POSSIBLE LEDGE BOTTOM  
EST. HIGH GW @ 24" EL=286.2

287.9 DTH #16

PAVEMENT	2"
GENERAL FILL	8"
LOAM SAND W/SOME LARGE BOULDERS	36"
SILTY LOAMY SAND W/RUST THRU-OUT	34"

SEEPAGE @ 60" EL=282.9  
MOTTLES @ 46" EL=284.07

297.5 DTH #17

HUMUS	6"
SUB SOIL	12"
GRAVEL COARSE SAND	36"
LOAMY SAND W/LARGE BOULDERS	47"
SANDY LOAM W/RUST	20"

WATER FLOW IN GRAVEL AND SAND @101" ELEV=289.08

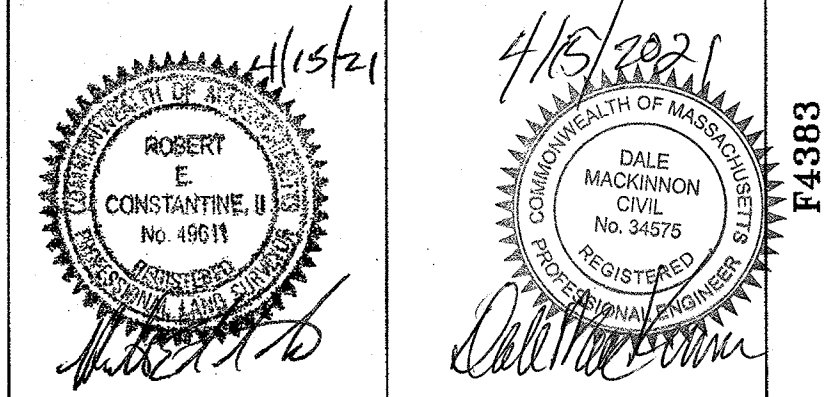

APPROVED DATE: \_\_\_\_\_  
FRANKLIN PLANNING BOARD  
\_\_\_\_\_  
\_\_\_\_\_  
\_\_\_\_\_  
BEING A MAJORITY

**LEGAL NOTES**

UTILITIES ARE PLOTTED AS A COMPILATION OF RECORD DOCUMENTS, MARKINGS AND OTHER OBSERVED EVIDENCE TO DEVELOP A VIEW OF THE UNDERGROUND UTILITIES AND SHOULD BE CONSIDERED APPROXIMATE. DURING EXCAVATION, THE EXACT LOCATION OF UNDERGROUND FEATURES CANNOT BE ACCURATELY, COMPLETELY AND RELIABLY DEPICTED. ADDITIONAL UTILITIES, NOT EVIDENCED BY RECORD DOCUMENTS OR OBSERVED PHYSICAL EVIDENCE, MAY EXIST. CONTRACTORS (IN ACCORDANCE WITH MASS.G.L. CHAPTER 82 SECTION 40 AS AMENDED) MUST CONTACT ALL UTILITY COMPANIES BEFORE EXCAVATING AND DRILLING AND CALL DIGSAFE AT 1(888)DIG-SAFE(7233).

CONSTRUCTION ON THIS LAND IS SUBJECT TO ANY EASEMENTS, RIGHTS-OF-WAY, RESTRICTIONS, RESERVATIONS, OR OTHER LIMITATIONS WHICH MAY BE REVEALED BY AN EXAMINATION OF THE TITLE.

**OWNER**

NORFOLK COUNTY DEVELOPMENT LLC  
185 QUINCY SHORE DRIVE, #26  
QUINCY, MA 02171

DEED BOOK 33300 PAGE 92  
PLAN NO. 40 OF 2014 PLAN BK. 628  
A.M. 270 LOT 29.2

**APPLICANT**

FRANKLIN LEARNING RE LLC.  
ATTN: MANOJ GANDHI  
206 GREAT ROAD  
LITTLETON, MA. 01460

**SITE PLAN MODIFICATION**  
**505 WEST CENTRAL STREET**  
**LOT 3**  
**(515 WEST CENTRAL STREET)**  
**FRANKLIN**  
**MASSACHUSETTS**

**EXISTING CONDITIONS**

**OCTOBER 21, 2020**

DATE	REVISION DESCRIPTION
12/22/2020	PER TOWN COMMENTS
4/8/21	PER TOWN COMMENTS & REQUESTS
4/15/21	REVISED PARKING LAYOUT

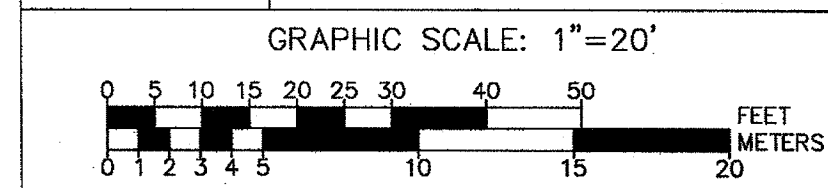

**Guerriere & Halnon, Inc.**  
ENGINEERING & LAND SURVEYING

55 WEST CENTRAL ST. PH. (508) 528-3221  
FRANKLIN, MA 02038 FX. (508) 528-7921  
www.gandhengineering.com

D:\Projects\2021\4383\DWG\F4383-B ASE.dwg, 4/15/2021 9:35:32 AM, DAB

**GENERAL EROSION CONTROL AND CONSTRUCTION NOTES**

1. THE LIMITS OF ALL CLEARING, GRADING AND DISTURBANCE SHALL BE KEPT TO A MINIMUM WITHIN THE PROPOSED AREA OF CONSTRUCTION. ALL AREAS OUTSIDE THE LIMITS OF DISTURBANCE SHALL REMAIN TOTALLY UNDISTURBED.
2. INSPECT SEDIMENT AND EROSION CONTROL MEASURES AT LEAST ONCE PER WEEK AND WITHIN 24 HOURS AFTER EVERY RAINFALL EVENT.
3. MAINTAIN ALL EROSION AND SEDIMENT CONTROL MEASURES OR REPLACE AS REQUIRED TO ASSURE PROPER FUNCTION.
4. CONTRACTOR SHALL IMMEDIATELY REPAIR ANY AND ALL EROSION AND SEDIMENT CONTROLS FOUND TO BE FAULTY.
5. ANY AND ALL DEBRIS AND LITTER WHICH ACCUMULATES IN THE BASINS SHALL BE REMOVED WEEKLY.
6. THE CONTRACTOR SHALL IMPLEMENT ALL REASONABLE EROSION AND SEDIMENT CONTROLS PRIOR TO THE ACTUAL COMMENCEMENT OF CONSTRUCTION ACTIVITIES INCLUDING THE CLEARING AND/OR GRUBBING OF ANY PORTION OF THE PROPERTY. THESE MEASURES SHALL BE MAINTAINED IN EFFECT THROUGHOUT THE ENTIRE CONSTRUCTION PHASE, OR UNTIL THE SITE HAS BECOME STABILIZED WITH AN ADEQUATE VEGETATIVE COVER.
7. SEDIMENT BUILD UP BEHIND FILTERMATS SHALL BE MONITORED AND BE REMOVED WHENEVER IT HAS ACCUMULATED TO FOUR INCHES IN DEPTH.
8. CATCH BASINS SHALL BE PROTECTED WITH SILT FILTERS (SILT SACKS). INSPECT SEDIMENT FILTERS AT LEAST ONCE PER WEEK AND WITHIN 24 HOURS AFTER RAINFALL THAT PRODUCES RUNOFF. CLEAN OR REPLACE FILTERS WITHIN 24 HOURS OF INSPECTION WHEN SEDIMENT REACHES ONE HALF OF THE FILTER SACK DEPTH. CATCH BASINS SHALL BE PROTECTED BY SEDIMENT FILTERS THROUGHOUT THE CONSTRUCTION PERIOD AND UNTIL ALL DISTURBED AREAS ARE THOROUGHLY STABILIZED. SUMPS SHALL BE CLEANED WHENEVER SEDIMENT HAS ACCUMULATED TO A DEPTH OF 24 INCHES AND IMMEDIATELY FOLLOWING INSTALLATION OF PERMANENT PAVEMENT.
10. THE CONTRACTOR SHALL MAINTAIN AN ADEQUATE STOCKPILE OF EROSION CONTROL MATERIALS ON-SITE AT ALL TIMES FOR EMERGENCY OR REPAIR OR REPLACEMENT AND SHALL INCLUDE MATERIALS TO REPLACE OR REPAIR SILT FENCE, MULCH SOCK, STONE FILTER DIKES OR ANY OTHER DEVICES PLANNED FOR USE DURING CONSTRUCTION.
11. THE CONTRACTOR IS TO INSPECT ALL CONTROLS NO LESS THAN WEEKLY, AND IN ANTICIPATION OF RAINFALL EVENTS EXPECTED TO EXCEED 1/2 INCH IN DEPTH. ALL DEFICIENCIES NOTED DURING SAID INSPECTION SHALL BE REPAIRED IMMEDIATELY AND IN NO CASE SHALL A DEFICIENCY BE ALLOWED TO GO UNCORRECTED DURING A RAINFALL EVENT. THE EROSION CONTROL DEVICES SHALL BE MAINTAINED, REINFORCED, OR REPLACED IF NECESSARY. ALL ACCUMULATED SEDIMENTS AND OTHER MATERIALS COLLECTED.
12. BY THE SEDIMENTATION CONTROL SYSTEMS SHALL BE REMOVED AS NECESSARY TO INSURE PROPER FUNCTION OF SYSTEMS AND DISPOSED OF IN A MANNER THAT IS CONSISTENT WITH THE INTENT OF THIS PLAN, IN AN UPLAND AREA.
13. TEMPORARY EARTH OR STONE DIKES, DRAINAGE SWALES AND/OR TEMPORARY SLOPE DRAINS SHALL BE ESTABLISHED AS SOON AS POSSIBLE. DISTURBED AREAS THAT ARE NOT SUBJECT TO CONSTRUCTION TRAFFIC SHALL RECEIVE A PERMANENT OR TEMPORARY VEGETATIVE COVER AS SOON AS FINAL CONTOURS ARE ESTABLISHED. TEMPORARY VEGETATIVE COVER IS TO BE ESTABLISHED ON ALL DISTURBED AREAS WHERE CONSTRUCTION ACTIVITIES WILL NOT REQUIRE ADDITIONAL DISTURBANCE FOR PERIOD OF 30 DAYS OR MORE. IF THE SEASON PREVENTS THE ESTABLISHMENT OF VEGETATIVE COVER, DISTURBED AREAS SHALL BE MULCHED AND THEN SEEDED AS SOON AS WEATHER CONDITIONS ALLOW.
16. THERE SHALL BE NO DIRECT DISCHARGE OF DEWATERING OPERATIONS INTO ANY DRAINAGE SYSTEM UNLESS THIS DISCHARGE IS CLEAN AND FREE OF SETTLEABLE SOLIDS. ANY DEWATERING DISCHARGE CONTAINING SETTLEABLE SOLIDS (SEDIMENTS) SHALL BE PASSED THROUGH A SEDIMENTATION CONTROL DEVICE (FILTER BAG) TO REMOVE THESE SOLIDS. THE CONTRACTOR IS TO MAINTAIN SAID SEDIMENT CONTROL DEVICE THROUGHOUT THE ENTIRE DEWATERING OPERATION AND REPAIR DEFICIENCIES IMMEDIATELY.
17. SOIL STOCKPILE AREAS FOR CONSTRUCTION MATERIALS SHALL BE LOCATED OUTSIDE WETLAND AREAS AND ASSOCIATED BUFFERS.
18. ALL PLANTINGS SHALL BE ACCOMPLISHED BY THE CONTRACTOR AS EARLY AS POSSIBLE UPON COMPLETION OF GRADING AND CONSTRUCTION.
19. ALL PLANTINGS SHALL BE WATERED AND MAINTAINED BY THE CONTRACTOR TO ENSURE SURVIVAL.
20. EROSION CONTROL SHALL REMAIN IN PLACE UNTIL THE CERTIFICATE OF COMPLETION IS ISSUED.

**INTERIM EROSION CONTROL AND CONSTRUCTION SEQUENCE**

1. INSTALL EROSION CONTROL BARRIERS AND HAVE ENGINEER INSPECT AND PREPARE LETTER.
2. RAZE THE EXISTING BUILDINGS, PAVEMENT, WALKWAYS, ETC CLEAR SITE OF ALL TREES DESIGNATED TO BE REMOVED.
3. CONSTRUCT A TEMPORARY BASIN TO COLLECT RUNOFF DURING CONSTRUCTION.
4. STOCKPILE LOAM, OR REMOVE LOAM.
5. INSTALL PIPES FOR DRAINAGE SYSTEMS. INSTALL DISCHARGE POINT ON EACH SYSTEM.
6. BRING SITE TO SUB-GRADE.
7. ALL SLOPES ALONG THE PROPERTY LINES SHALL BE MULCHED TEMPORARILY, IF DISTURBED.
8. TEMPORARY STONE (3/4" - 1 1/2") SHALL BE PLACED AT THE PROJECT ENTRANCE WHEN ACCESSING EXISTING PAVEMENT. SWEEPING IS REQUIRED IF FINES ARE OBSERVED IN THE PARKING LOT OR PUBLIC WAYS.
9. ALL DISTURBED AREAS NOT TREATED WITH PERMANENT LOAM AND SEED SHALL BE COVERED WITH MULCH, OR OTHER EROSION CONTROL DEVICE.
10. ALL CONSTRUCTION GRADES IN THE INTERIM SHALL BE SLOPED TO FLOW INTO THE TEMPORARY BASIN, WHERE POSSIBLE.
11. THE SITE MITIGATION OF EROSION IN THOSE AREAS TO BE LANDSCAPED OR MULCHED SHALL BE TO INSTALL AS SOON AS POSSIBLE.
12. CLEAN ALL SEDIMENT OUT OF TEMPORARY BASIN AND INSTALL CLEAN FILL PER PLAN SPECIFICATIONS PRIOR TO FINAL GRADING AND SURFACE STABILIZATION.
13. THE SUBSURFACE DRAINAGE SYSTEM SHALL BE INSTALLED PRIOR TO PAVEMENT INSTALLATION. PROPER FILTERFABRIC SHALL BE PLACED AT INLETS TO KEEP THE STORM DRAINAGE CLEAN OF DEBRIS.
14. ONCE THE CURB IS INSTALLED, THE PERMANENT MULCH AND LANDSCAPING SHALL BE INSTALLED.
15. SEDIMENT CONTROL SHALL REMAIN IN PLACE UNTIL THE SITE IS STABILIZED.
16. CLEAN ALL ON SITE CATCH BASINS, MANHOLES, PIPING, TEMPORARY BASIN, AND INFILTRATION CHAMBERS. INSTALL SILT BAGS AT EACH CATCH BASIN.
17. KEEP SITE SWEEP AND MAINTAINED PER STORMWATER MANAGEMENT PLAN.

**LEGEND**

☐	CATCH BASIN	☆	LIGHT POLE
⊙	DRAIN MANHOLE	⊙	UTILITY POLE
⊕	ELECTRIC MANHOLE	•	GUY WIRE
⊗	SEWER MANHOLE	—	SIGN
○	MANHOLE	•	WETFLAG
⊕	GAS VALVE	⊙	UTILITY POLE
⊕	GAS SHUT OFF VALVE	⊕	PROP. PARKING LIGHTING
⊕	WATER VALVE	⊕	PROP. SECURITY LIGHTING
⊕	WATER SHUT OFF VALVE	X 000.0	SPOT ELEVATION
⊕	FIRE HYDRANT	▨	RIPRAP
— 000 —	EXISTING CONTOUR		
— D —	EXISTING DRAIN LINE		
— W —	EXISTING WATER LINE		

**SECTION END VIEW**

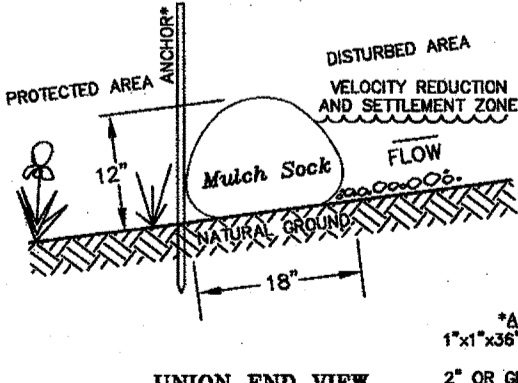

**SECTION TOP VIEW**

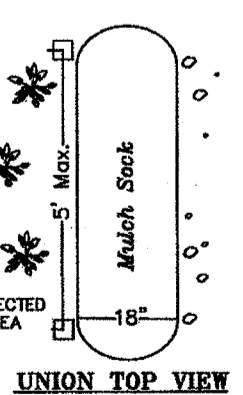

1. WHERE SECTION ENDS MEET, THERE SHALL BE AN OVERLAP OF 6" OR GREATER. BOTH SIDES SHALL BE ANCHORED (OAK STAKES, TREES, ETC.) TO STABILIZE THE UNION.
2. NO ADDITIONAL ANCHORS ARE REQUIRED ON SLOPES LESS THAN 2:1.
3. ADDITIONAL ANCHORS ARE REQUIRED AT 5' INTERVALS (MAX.) ON THE DOWNSLOPE OR PROTECTED SIDE ON SLOPES GREATER THAN 2:1 TO PREVENT MOVEMENT.

**EROSION CONTROL BARRIER**  
NOT TO SCALE

- Mulch Sock COMPONENTS:**
- OUTSIDE CASING: 100% organic hessian.
  - FILLER INGREDIENT: FiberRoot Mulch
  - A blend of coarse and fine compost and shredded wood.
  - Particle sizes: 100% passing a 3" screen; 90-100% passing a 1" screen; 70-100% passing a 0.75" screen; 30-75% passing a 0.25" screen.
  - Weight: Approx. 850 lbs./cu.yd. (Ave. 30 lbs./ft.)

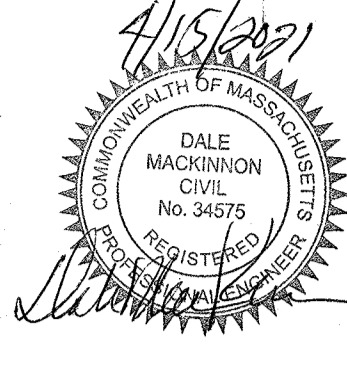
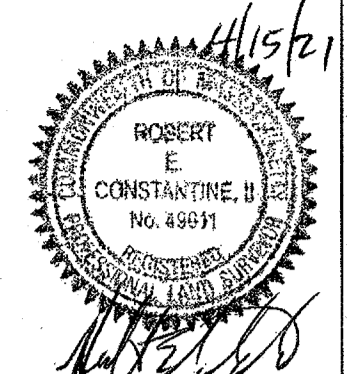
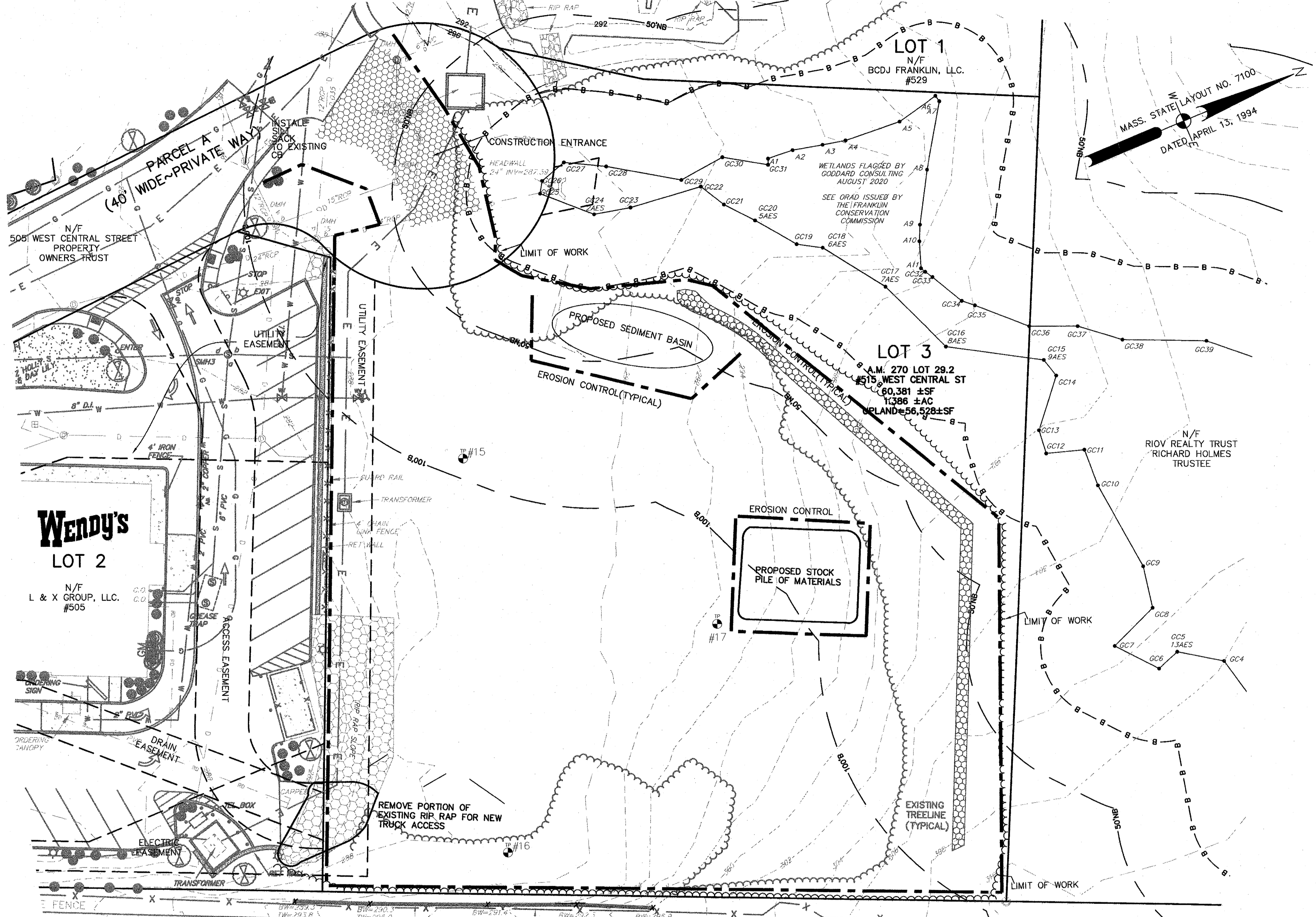

F4383

APPROVED DATE:  
FRANKLIN PLANNING BOARD  
\_\_\_\_\_  
\_\_\_\_\_  
\_\_\_\_\_  
\_\_\_\_\_  
BEING A MAJORITY

**LEGAL NOTES**

UTILITIES ARE PLOTTED AS A COMPILATION OF RECORD DOCUMENTS, MARKINGS AND OTHER OBSERVED EVIDENCE TO DEVELOP A VIEW OF THE UNDERGROUND UTILITIES AND SHOULD BE CONSIDERED APPROXIMATE. EXCAVATION, THE EXACT LOCATION OF UNDERGROUND FEATURES CANNOT BE ACCURATELY, COMPLETELY AND RELIABLY DEPICTED. ADDITIONAL UTILITIES, NOT EVIDENCED BY RECORD DOCUMENTS OR OBSERVED PHYSICAL EVIDENCE, MAY EXIST. CONTRACTORS (IN ACCORDANCE WITH MASS.G.L. CHAPTER 82 SECTION 40 AS AMENDED) MUST CONTACT ALL UTILITY COMPANIES BEFORE EXCAVATING AND DRILLING AND CALL DIGSAFE AT (888)DIG-SAFE(7233).

CONSTRUCTION ON THIS LAND IS SUBJECT TO ANY EASEMENTS, RIGHTS-OF-WAY, RESTRICTIONS, RESERVATIONS, OR OTHER LIMITATIONS WHICH MAY BE REVEALED BY AN EXAMINATION OF THE TITLE.

**OWNER**

NORFOLK COUNTY DEVELOPMENT LLC  
185 QUINCY SHORE DRIVE, #26  
QUINCY, MA 02171

DEED BOOK 33300 PAGE 92  
PLAN NO. 40 OF 2014 PLAN BK. 628  
A.M. 270 LOT 29.2

**APPLICANT**

FRANKLIN LEARNING RE LLC.  
ATTN: MANOJ GANDHI  
206 GREAT ROAD  
LITTLETON, MA. 01460

**SITE PLAN MODIFICATION**  
**505 WEST CENTRAL STREET**  
**LOT 3**  
**(515 WEST CENTRAL STREET)**  
**FRANKLIN**  
**MASSACHUSETTS**

**EROSION CONTROL PLAN**

**OCTOBER 21, 2020**

DATE	REVISION DESCRIPTION
12/22/2020	PER TOWN COMMENTS
4/8/21	PER TOWN COMMENTS & REQUESTS
4/15/21	REVISED PARKING LAYOUT

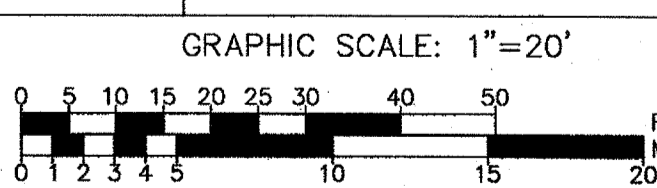

**Guerriere & Halnon, Inc.**  
ENGINEERING & LAND SURVEYING  
55 WEST CENTRAL ST. PH. (508) 528-3221  
FRANKLIN, MA 02038 FX. (508) 528-7921  
www.gandhengineering.com

**PARKING NOTES**

PARKING REQUIREMENTS PER ZONING:  
(PER TEACHER CAPACITY)

HOURS OF OPERATION:  
NORMAL REGULAR HOURS 6:30AM-6:00PM

TEACHER SCHEDULES:  
20-22 TEACHERS WILL BE ON SITE AT PEAK HOURS  
MAXIMUM TOTAL TEACHER PARKING REQUIRED= 22 PARKING SPACES

TOTAL PARKING SPACES PROVIDED = 33 PARKING SPACES

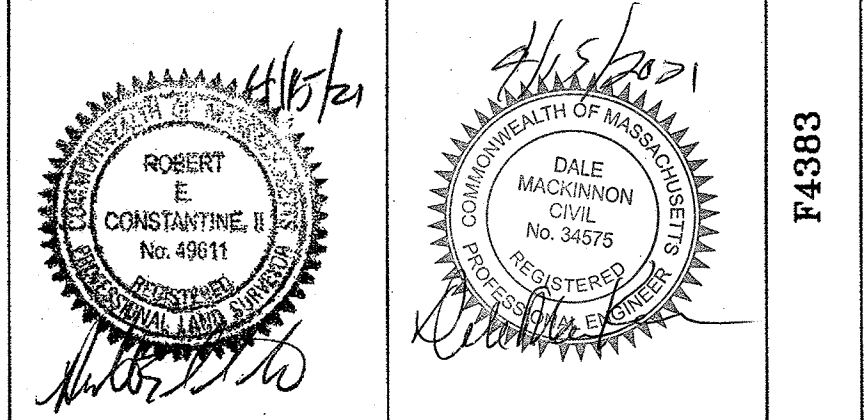
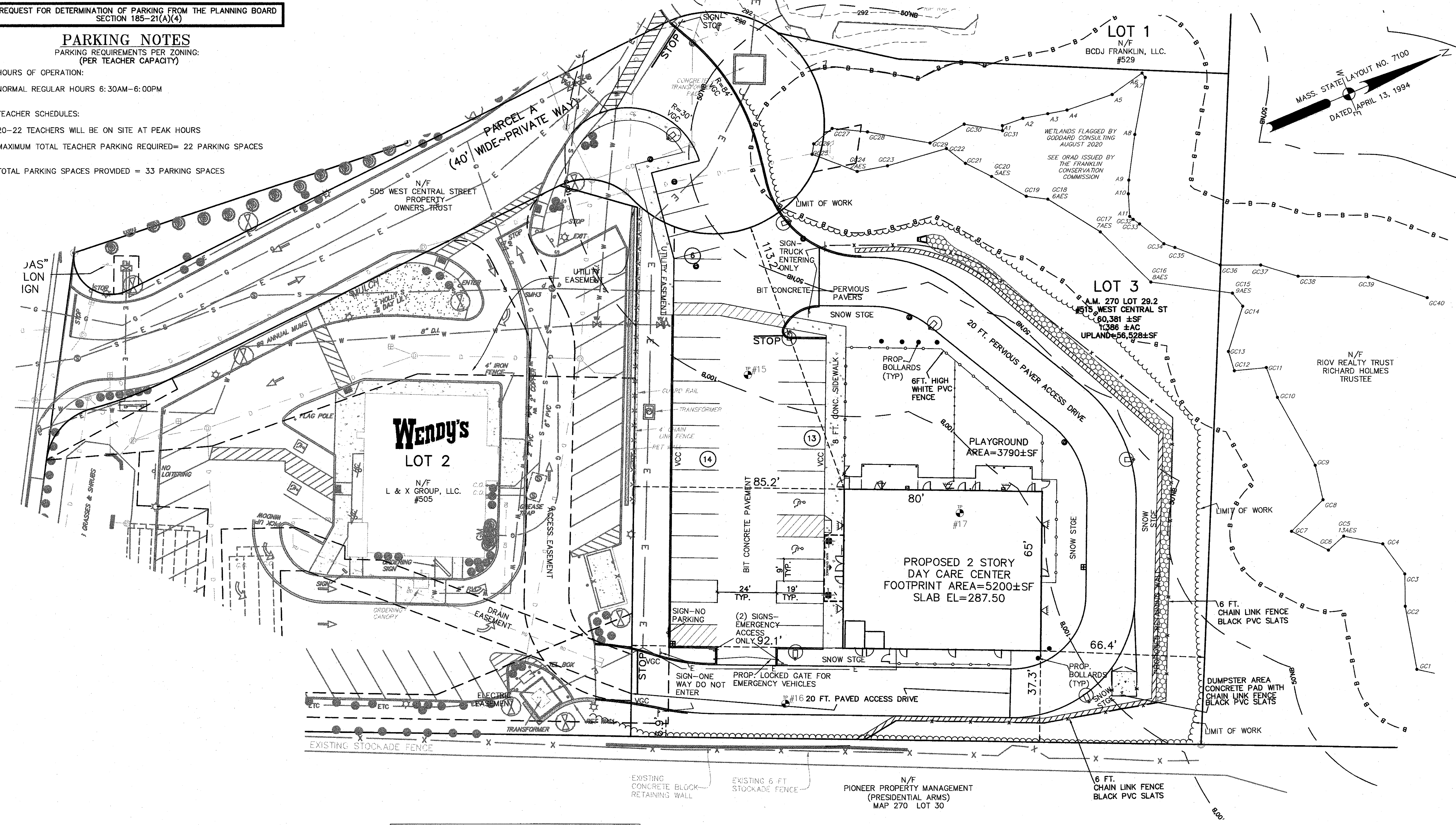

APPROVED DATE:  
FRANKLIN PLANNING BOARD

BEING A MAJORITY

**LEGAL NOTES**

UTILITIES ARE PLOTTED AS A COMPILATION OF RECORD DOCUMENTS, MARKINGS AND OTHER OBSERVED EVIDENCE TO DEVELOP A VIEW OF THE UNDERGROUND UTILITIES AND SHOULD BE CONSIDERED APPROXIMATE. UNLESS EXCAVATION, THE EXACT LOCATION OF UNDERGROUND FEATURES CANNOT BE ACCURATELY, COMPLETELY AND RELIABLY DEPICTED. ADDITIONAL UTILITIES, NOT EVIDENCED BY RECORD DOCUMENTS OR OBSERVED PHYSICAL EVIDENCE, MAY EXIST. CONTRACTORS (IN ACCORDANCE WITH MASS.G.L. CHAPTER 82 SECTION 40 AS AMENDED) MUST CONTACT ALL UTILITY COMPANIES BEFORE EXCAVATING AND DRILLING AND CALL DIGSAFE AT 1(888)DIG-SAFE(7233).

CONSTRUCTION ON THIS LAND IS SUBJECT TO ANY EASEMENTS, RIGHTS-OF-WAY, RESTRICTIONS, RESERVATIONS, OR OTHER LIMITATIONS WHICH MAY BE REVEALED BY AN EXAMINATION OF THE TITLE.

**OWNER**  
NORFOLK COUNTY DEVELOPMENT LLC  
185 QUINCY SHORE DRIVE, #26  
QUINCY, MA 02171

DEED BOOK 33300 PAGE 92  
PLAN NO. 40 OF 2014 PLAN BK. 628  
A.M. 270 LOT 29.2

**APPLICANT**  
FRANKLIN LEARNING RE LLC.  
ATTN: MANOJ GANDHI  
206 GREAT ROAD  
LITTLETON, MA. 01460

**SITE PLAN MODIFICATION**  
505 WEST CENTRAL STREET  
LOT 3  
(515 WEST CENTRAL STREET)  
FRANKLIN  
MASSACHUSETTS

**SITE PLAN**

**OCTOBER 21, 2020**

DATE	REVISION DESCRIPTION
12/22/2020	PER TOWN COMMENTS
2/23/21	REVISED PARKING
4/8/21	PER TOWN COMMENTS & REQUESTS
4/15/21	REVISED PARKING LAYOUT

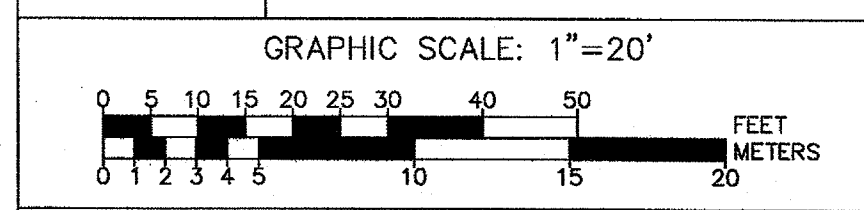

**Guerriere & Halnon, Inc.**  
ENGINEERING & LAND SURVEYING

55 WEST CENTRAL ST. PH. (508) 528-3221  
FRANKLIN, MA 02038 FX. (508) 528-7921  
www.gandhengineering.com

**LEGEND**

⊞	CATCH BASIN	☆	LIGHT POLE
⊙	DRAIN MANHOLE	⊕	UTILITY POLE
⊕	ELECTRIC MANHOLE	•	GUY WIRE
⊙	SEWER MANHOLE	—	SIGN
⊙	MANHOLE	•	WETFLAG
⊕	GAS VALVE	⊕	UTILITY POLE
⊕	GAS SHUT OFF VALVE	⊕	PROP. PARKING LIGHTING
⊕	WATER VALVE	⊕	PROP. SECURITY LIGHTING
⊕	WATER SHUT OFF VALVE	x 000.0	SPOT ELEVATION
⊕	FIRE HYDRANT	⊕	RIPRAP
— 000 —	EXISTING CONTOUR		
— D —	EXISTING DRAIN LINE		
— W —	EXISTING WATER LINE		

ZONING AT THE TIME OF SITE PLAN APPROVAL APRIL 11, 2011

FRONT 40'  
SIDE 20'  
REAR 30'

	REQUIRED	APPROVED 2011	LOT 3 (DAY CARE) PROPOSED (2020)	PROPOSED 2020 TOTAL SITE
MINIMUM LOT AREA	40,000 SF		60,381±SF	173,585±SF
MINIMUM LOT FRONTAGE	175'		182.07'	
MINIMUM LOT DEPTH	200'		276'	
MINIMUM LOT WIDTH	157.5'		170±'	
MINIMUM YARDS				
FRONT	40'		115.6'	
SIDE	30'		59.6'	
REAR	30'		37.3'	
BUILDING HEIGHT				
STORIES	3 <sup>15</sup>		2 STORIES	
FEET	40' <sup>15</sup>		33'4"	
% OF LOT UPLAND COVERED BY:				
STRUCTURES	70	7%	9.2% (5200±SF.)	8.0% (13,950±SF.)
STRUCTURES+PAVING	80	52.3%	33.5% (20,216±SF. UPLAND)	51.0% (88,598±SF.)

<sup>15</sup> BUILDINGS UP TO 50 FEET IN HEIGHT, REGARDLESS OF THE NUMBER OF STORIES, MAY BE PERMITTED BY A SPECIAL PERMIT FROM THE PLANNING BOARD

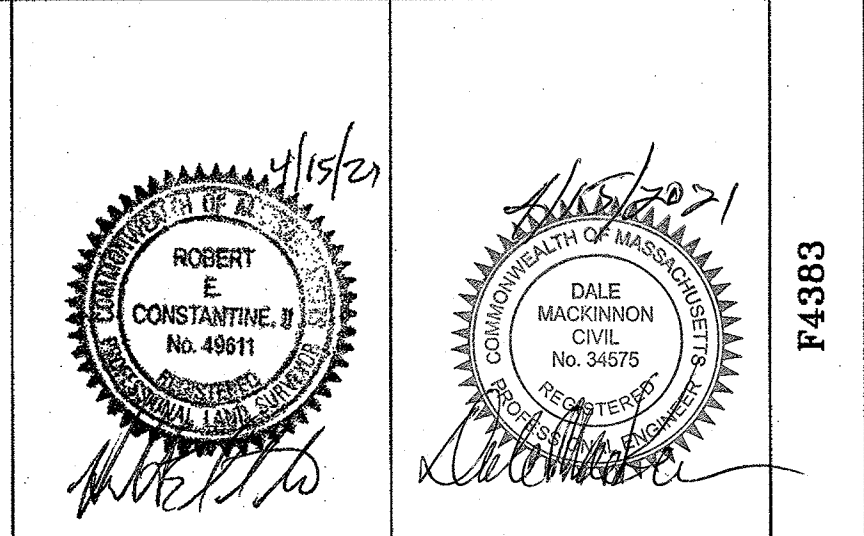
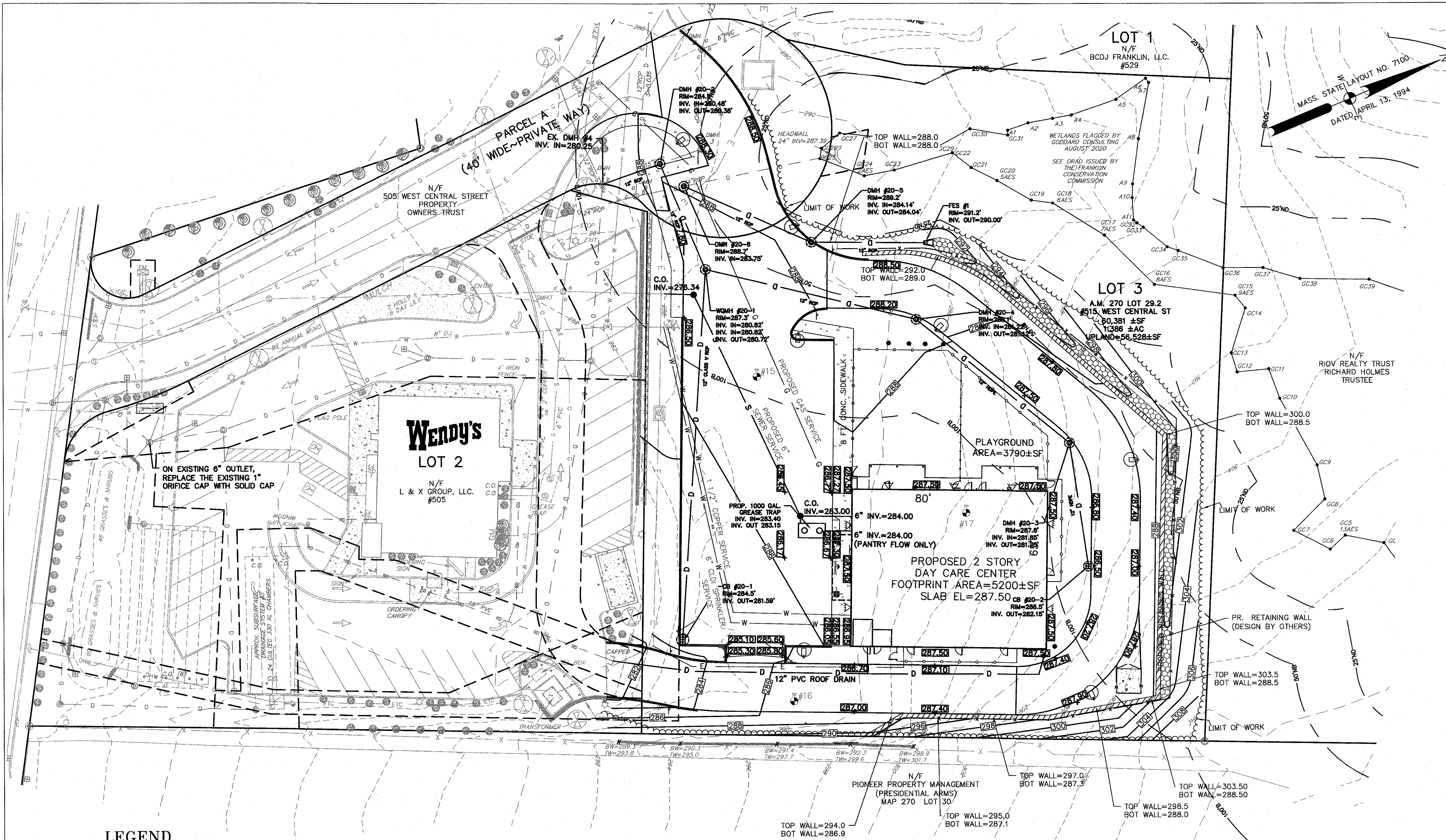

APPROVED DATE: \_\_\_\_\_  
 FRANKLIN PLANNING BOARD  
 \_\_\_\_\_  
 \_\_\_\_\_  
 \_\_\_\_\_  
 \_\_\_\_\_  
 BEING A MAJORITY

**LEGAL NOTES**  
 UTILITIES ARE PLOTTED AS A COMPILATION OF RECORD DOCUMENTS, MARKINGS AND OTHER OBSERVED EVIDENCE TO DEVELOP A VIEW OF THE UNDERGROUND UTILITIES AND SHOULD BE CONSIDERED APPROXIMATE. DURING EXCAVATION, THE EXACT LOCATION OF UNDERGROUND FEATURES CANNOT BE ACCURATELY, COMPLETELY AND RELIABLY DEPICTED. ADDITIONAL UTILITIES, NOT EVIDENCED BY RECORD DOCUMENTS OR OBSERVED PHYSICAL EVIDENCE, MAY EXIST. CONTRACTORS (IN ACCORDANCE WITH MASS.G.L. CHAPTER 82 SECTION 40 AS AMENDED) MUST CONTACT ALL UTILITY COMPANIES BEFORE EXCAVATING AND DRILLING AND CALL DIGSAFE AT 1(888)DIG-SAFE(7233).

CONSTRUCTION ON THIS LAND IS SUBJECT TO ANY EASEMENTS, RIGHTS-OF-WAY, RESTRICTIONS, RESERVATIONS, OR OTHER LIMITATIONS WHICH MAY BE REVEALED BY AN EXAMINATION OF THE TITLE.

**OWNER**  
 NORFOLK COUNTY DEVELOPMENT LLC  
 185 QUINCY SHORE DRIVE, #26  
 QUINCY, MA 02171

**DEED BOOK 33300 PAGE 92  
 PLAN NO. 40 OF 2014 PLAN BK. 628  
 A.M. 270 LOT 29.2**

**APPLICANT**  
 FRANKLIN LEARNING RE LLC.  
 ATTEN: MANOJ GANDHI  
 206 GREAT ROAD  
 LITTLETON, MA. 01460

**SITE PLAN MODIFICATION  
 505 WEST CENTRAL STREET  
 LOT 3  
 (515 WEST CENTRAL STREET)  
 FRANKLIN  
 MASSACHUSETTS  
 GRADING & UTILITY  
 PLAN**

**OCTOBER 21, 2020**

DATE	REVISION DESCRIPTION
12/22/2020	PER TOWN COMMENTS
4/8/21	PER TOWN COMMENTS & REQUESTS
4/15/21	REVISED PARKING LAYOUT

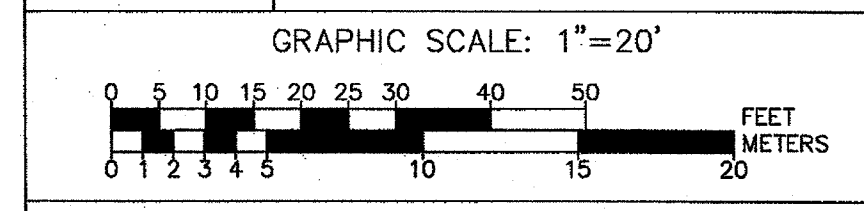

**Guerriere & Halnon, Inc.**  
 ENGINEERING & LAND SURVEYING  
 55 WEST CENTRAL ST. PH. (508) 528-3221  
 FRANKLIN, MA 02038 FX. (508) 528-7921  
 www.gandhengineering.com

G:\C:\JDFromelin\F4383\DWG\F4383-SITE-revision.dwg, 4/15/2021 3:50:35 PM, [REC]

**LEGEND**

⊞	CATCH BASIN	☆	LIGHT POLE
⊙	DRAIN MANHOLE	⊙	UTILITY POLE
⊕	ELECTRIC MANHOLE	→	GUY WIRE
⊗	SEWER MANHOLE	⊖	SIGN
○	MANHOLE	•	WETFLAG
⊕	GAS VALVE	⊙	UTILITY POLE
⊕	GAS SHUT OFF VALVE	⊕	PROP. PARKING LIGHTING
⊕	WATER VALVE	⊕	PROP. SECURITY LIGHTING
⊕	WATER SHUT OFF VALVE	X 000.0	SPOT ELEVATION
⊕	FIRE HYDRANT	⊕	RIPRAP
---	EXISTING CONTOUR		
---	EXISTING DRAIN LINE		
---	EXISTING WATER LINE		

**STORM DRAINAGE NOTES**

- SPECIAL CONSIDERATION FOR INLET CONTROLS FOR EROSION COLLECTION BEFORE ENTERING DRAINAGE SYSTEM:
- INSTALL SILT SACKS.
  - BARRIER AROUND CATCH BASIN, MULCH SOCK OR EQUAL
  - INSTALL FILTER FABRIC ON ALL DRAIN MANHOLE OUTLETS DISCHARGING TO INFILTRATION SYSTEM.
  - INSPECTIONS BEFORE AND AFTER STORM EVENTS ARE REQUIRED TO INSURE ADEQUACY OF EROSION CONTROL MEASURES.
  - CONTRACTOR & ARCHITECT ARE TO VERIFY SITE UTILITIES PRIOR TO DESIGN & CONSTRUCTION.
  - ALL PIPE GASKETS SHALL BE PRE-MOLDED NEOPRENE O-RING TYPE (300-11 B.(2)(A)).

**SITE DRAINAGE INSTALLATIONS NOTES**

- INSTALL CONNECTIONS TO CATCH BASINS, TSS REMOVAL UNIT AND DRAIN MANHOLES.

**UTILITY NOTE**

ALL UTILITIES SHALL BE CONSTRUCTED ACCORDING TO STATE AND LOCAL REGULATIONS.

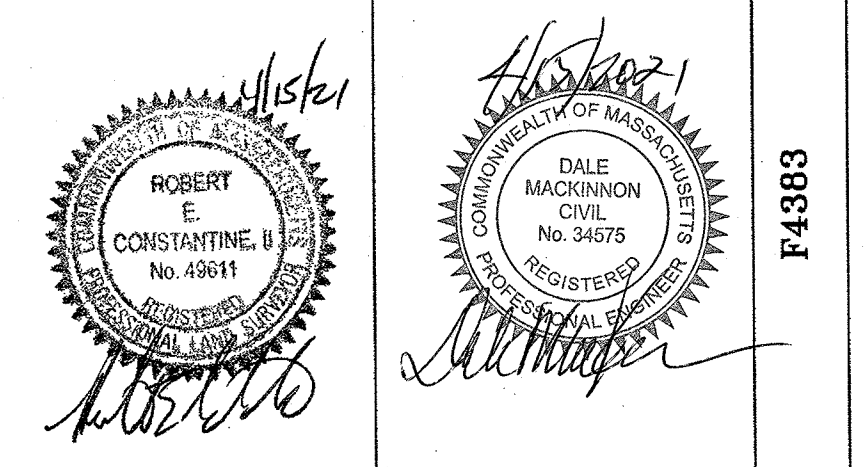
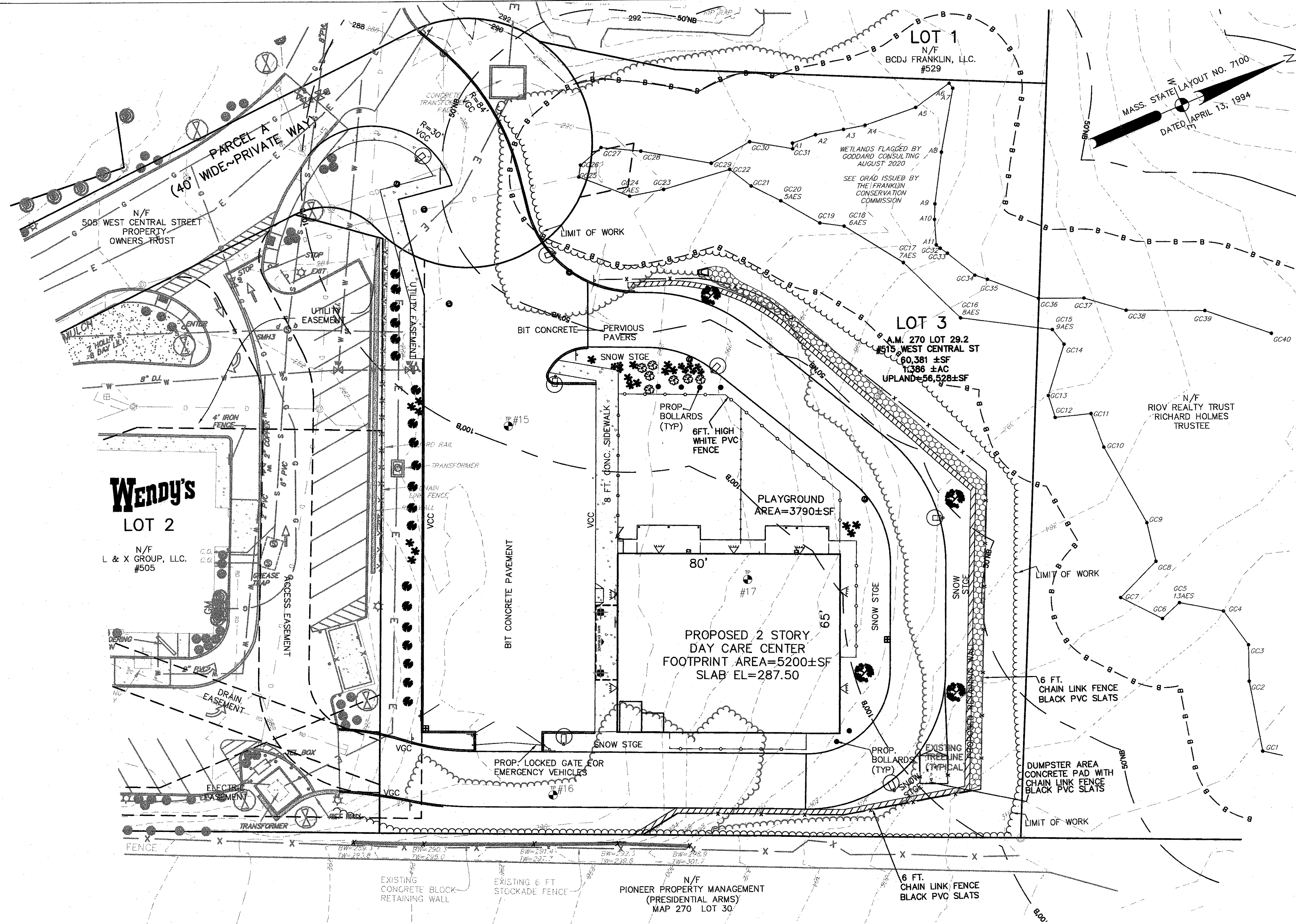

APPROVED DATE:  
FRANKLIN PLANNING BOARD  
  
BEING A MAJORITY

LEGAL NOTES  
UTILITIES ARE PLOTTED AS A COMPILATION OF RECORD DOCUMENTS, MARKINGS AND OTHER OBSERVED EVIDENCE TO DEVELOP A VIEW OF THE UNDERGROUND UTILITIES AND SHOULD BE CONSIDERED APPROXIMATE. DURING EXCAVATION, THE EXACT LOCATION OF UNDERGROUND FEATURES CANNOT BE ACCURATELY COMPLETELY AND RELIABLY DEPICTED. ADDITIONAL UTILITIES, NOT EVIDENCED BY RECORD DOCUMENTS OR OBSERVED PHYSICAL EVIDENCE, MAY EXIST. CONTRACTORS (IN ACCORDANCE WITH MASS.G.L. CHAPTER 82 SECTION 40 AS AMENDED) MUST CONTACT ALL UTILITY COMPANIES BEFORE EXCAVATING AND DRILLING AND CALL DIGSAFE AT 1(888)DIG-SAFE(7233).

CONSTRUCTION ON THIS LAND IS SUBJECT TO ANY EASEMENTS, RIGHTS-OF-WAY, RESTRICTIONS, RESERVATIONS, OR OTHER LIMITATIONS WHICH MAY BE REVEALED BY AN EXAMINATION OF THE TITLE.  
OWNER  
NORFOLK COUNTY DEVELOPMENT LLC  
185 QUINCY SHORE DRIVE, #26  
QUINCY, MA 02171  
DEED BOOK 33300 PAGE 92  
PLAN NO. 40 OF 2014 PLAN BK. 628  
A.M. 270 LOT 29.2  
APPLICANT  
FRANKLIN LEARNING RE LLC.  
ATTN: MANOJ GANDHI  
206 GREAT ROAD  
LITTLETON, MA. 01460

**SITE PLAN MODIFICATION**  
505 WEST CENTRAL STREET  
LOT 3  
(515 WEST CENTRAL STREET)  
FRANKLIN  
MASSACHUSETTS

**LANDSCAPING PLAN**

**OCTOBER 21, 2020**

DATE	REVISION DESCRIPTION
12/22/2020	PER TOWN COMMENTS
4/8/21	PER TOWN COMMENTS & REQUEST
4/15/21	REVISED PARKING LAYOUT

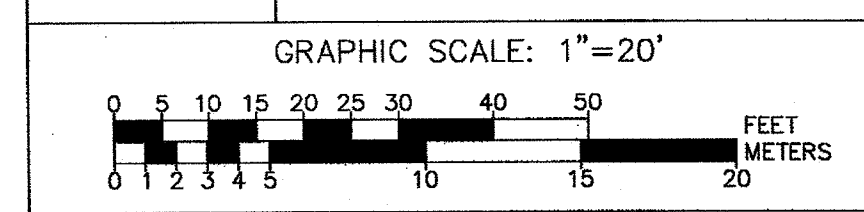

**Guerriere & Halnon, Inc.**  
ENGINEERING & LAND SURVEYING  
55 WEST CENTRAL ST. PH. (508) 528-3221  
FRANKLIN, MA 02038 FX. (508) 528-7921  
www.gandhengineering.com

SHEET 6 OF 10 JOB NO. F4383

**LEGEND**

	CATCH BASIN		LIGHT POLE
	DRAIN MANHOLE		UTILITY POLE
	ELECTRIC MANHOLE		GUY WIRE
	SEWER MANHOLE		SIGN
	MANHOLE		WETFLAG
	GAS VALVE		UTILITY POLE
	GAS SHUT OFF VALVE		PROP. PARKING LIGHTING
	WATER VALVE		PROP. SECURITY LIGHTING
	WATER SHUT OFF VALVE		SPOT ELEVATION
	FIRE HYDRANT		RIPRAP
	EXISTING CONTOUR		
	EXISTING DRAIN LINE		
	EXISTING WATER LINE		

**PLANTING LEGEND**

SYMBOL	NAME	SIZE	QUANTITY
	RED MAPLE ACER RUBRUM	4' MIN. 2.5" CAL.	7
	JUNIPER PLUMROSA COMPACTA	3 GAL.	19
	RHODODENDRON HENRY'S RED (DARK RED)	3 GAL.	7
	HERMOCADIS DAYLILIES	2 GAL.	9
	PYRAMIDIS ARBORVITAE THUJA ACCIDENTALIS	5' MIN.	20

**PLANTING NOTE**

ALL PLANTINGS TO CONFORM TO THE TOWN OF FRANKLIN BEST DEVELOPMENT STANDARD PRACTICES.

3:\C:\30\Franklin\F4383\DWG\F4383-SITE-revision3 final revision.dwg, 4/15/2021 9:38:51 AM, DAB

**Area Lighting**  
**Aeris™**

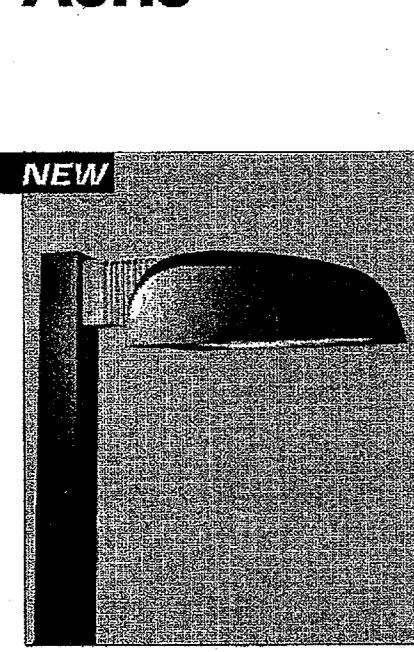

**Ordering Information**

Model	Options	Notes
AS1 355	SRB Segmented Type II roadway	1. Mount ordered with SCWA option.
AS1 355	SRB Segmented Type III roadway	2. May be ordered with SCWA option.
AS1 150S	SRAS Segmented Type IV roadway	3. Conduit for available photocell.
AS2 290S	SRW Segmented Type IV roadway	4. Optional anti-glare shield (AS2, AS2V, AS2V2).
AS2 290S	SRW Segmented Type IV roadway	5. Mounting block standard.
AS1 52M	SRSS Segmented Type V square	6. SC or CSB options cannot be ordered together.
AS1 70M	SRSS Segmented Type V square	7. Current factory for availability.
AS1 150M	SRSS Segmented Type V square	8. Includes arm.

**Architectural Arm-Mounted Cutoff**  
**Intended Use**  
 For streets, walkways, parking lots and surrounding areas.  
**Features**  
 Housing - Die-cast single piece aluminum with nominal 1/4" wall thickness. Integral arm provides easy installation to pole or wall. Housing completely sealed against moisture or environmental contaminants.  
 Door Assembly - Die-cast door frame, impact-resistant, tempered, glass lens, 3/4" thick, fully sealed with one-piece tubular silicone gasket. Tool-less entry and closure via spring loaded die-cast latches.  
 Optics - Anodized segmented reflectors for superior uniformity and control. Reflectors attach with tool-less fasteners and are rotatable and interchangeable.  
 Installation - Heavy duty easy mount block attaches to pole or wall to provide ease of installation as well as ensured alignment and leveling.

Example: AS1 150S SR2 120 SF LPI

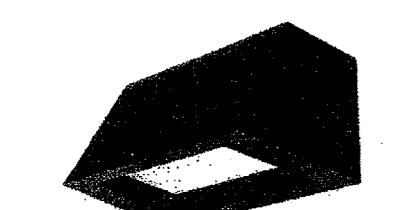

**WST LED Architectural Wall Sconce**

**Specifications Luminaire**  
 Height: 8.1/2" (215.9mm)  
 Width: 17" (431.8mm)  
 Depth: 10.3/16" (263.4mm)  
 Weight: 20 lbs (9.1kg)

**Optional Back Box (PBBW)**  
 Height: 8.1/2" (215.9mm)  
 Width: 17.0" (431.8mm)  
 Depth: 1.70" (43.2mm)

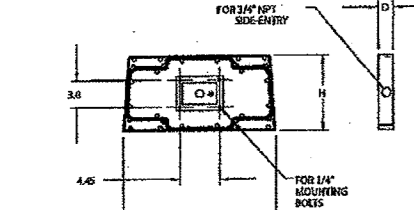

**Optional Back Box (BBW)**  
 Height: 6.1/2" (165.1mm)  
 Width: 5.1/2" (140.0mm)  
 Depth: 1.1/2" (38.1mm)

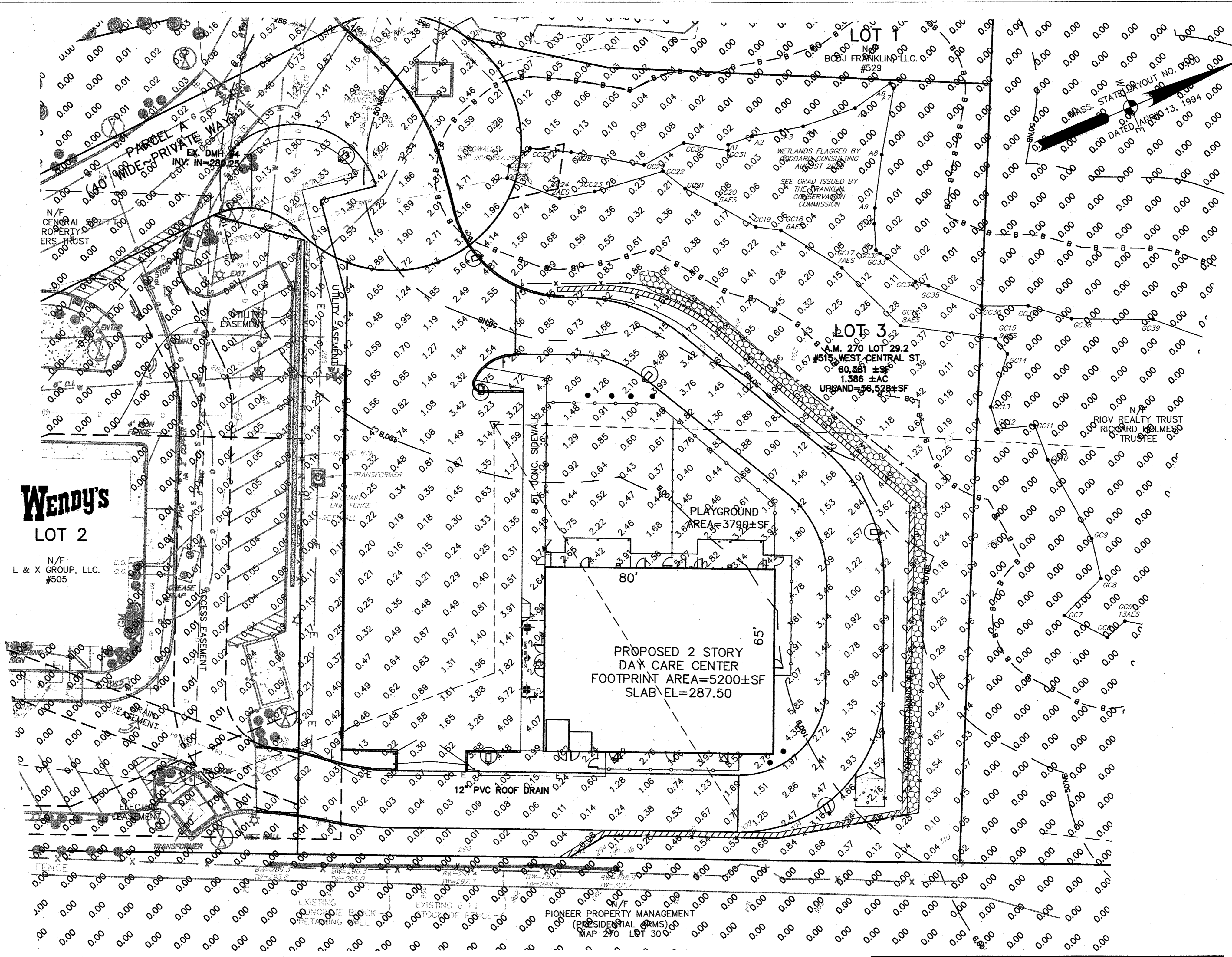
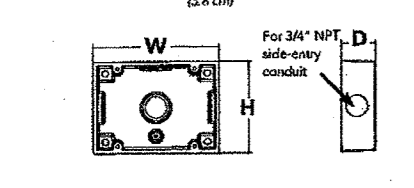

**LEGEND**

⊠	CATCH BASIN	☆	LIGHT POLE
⊙	DRAIN MANHOLE	⊕	UTILITY POLE
⊙	ELECTRIC MANHOLE	⊙	GUY WIRE
⊙	SEWER MANHOLE	—	SIGN
○	MANHOLE	•	WETFLAG
⊕	GAS VALVE	⊕	UTILITY POLE
⊕	GAS SHUT OFF VALVE	⊕	PROP. PARKING LIGHTING
⊕	WATER VALVE	⊕	PROP. SECURITY LIGHTING
⊕	WATER SHUT OFF VALVE	X 000.0	SPOT ELEVATION
⊕	FIRE HYDRANT	▨	RIPRAP

THIS PHOTOMETRIC PLAN IS BASED SOLELY UPON PROPRIETARY INFORMATION SUPPLIED BY THE LUMINAIRE MANUFACTURER AND CLIENT RECOMMENDATION.

LUMINAIRE LOCATIONS, LIGHTING PATTERNS, AND ILLUMINATION LEVELS WERE PREPARED UTILIZING INFORMATION SUPPLIED BY THE LUMINAIRE MANUFACTURER AND THE SOFTWARE PACKAGE SIMPLY OUTDOOR. IT'S VALUES SHOULD BE CONSIDERED APPROXIMATE IN NATURE AND SHALL BE VERIFIED BY THE LUMIN MANUFACTURER PRIOR TO INSTALLATION.

ACTUAL PERFORMANCE OF LIGHTING PATTERNS AND/OR ILLUMINATION VALUES MAY VARY DUE TO VARIATIONS IN LIGHT HEIGHT, ELECTRICAL VOLTAGE, LAMP WATTAGE, AND OTHER VARIABLE FIELD CONDITIONS, OR USING A LUMINAIRE OTHER THAN SPECIFICALLY NOTED HEREON.

GUERRIERE & HALNON, INC ASSUMES NO RESPONSIBILITY FOR ANY SAFETY AND/OR SECURITY RISKS DUE TO INADEQUATE LIGHT LEVELS WHICH MAY OCCUR AFTER INSTALLATION.

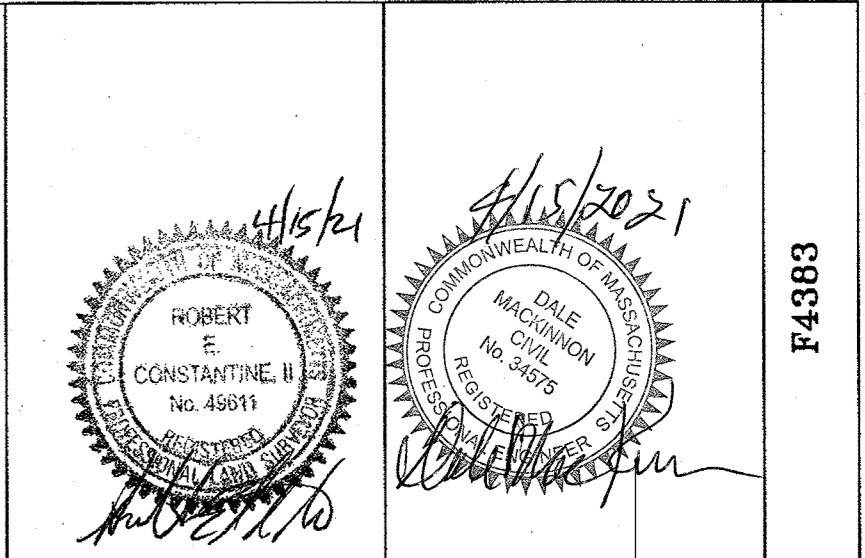
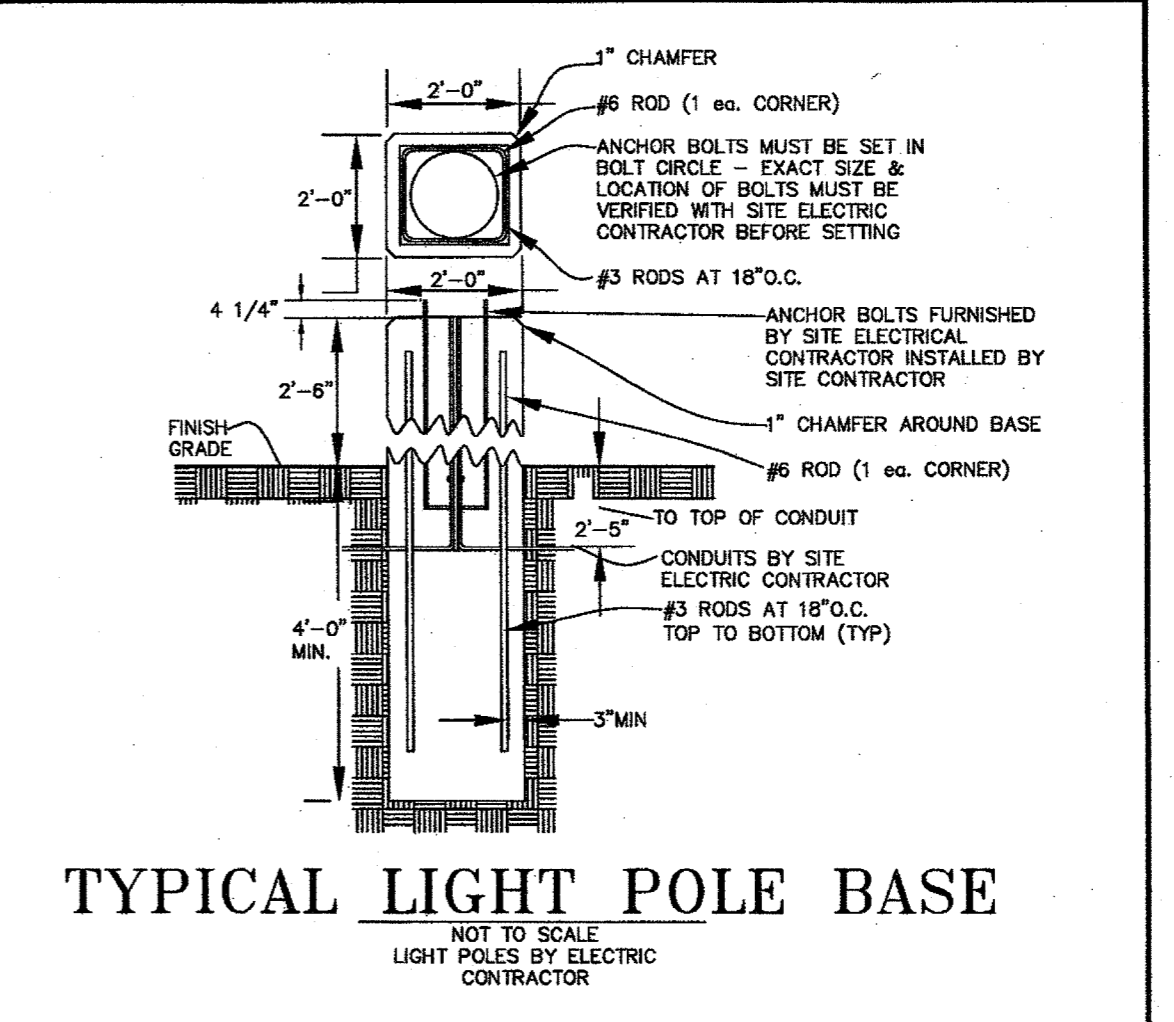

APPROVED DATE:  
 FRANKLIN PLANNING BOARD

BEING A MAJORITY

LEGAL NOTES

UTILITIES ARE PLOTTED AS A COMPILATION OF RECORD DOCUMENTS, MARKINGS AND OTHER OBSERVED EVIDENCE TO DEVELOP A VIEW OF THE UNDERGROUND UTILITIES AND SHOULD BE CONSIDERED APPROXIMATE. EXCAVATING THE EXACT LOCATION OF UNDERGROUND FEATURES CANNOT BE ACCURATELY, COMPLETELY AND RELIABLY DEPICTED. ADDITIONAL UTILITIES, NOT EVIDENCED BY RECORD DOCUMENTS OR OBSERVED PHYSICAL EVIDENCE, MAY EXIST. CONTRACTORS (IN ACCORDANCE WITH MASS.G.L. CHAPTER 82 SECTION 40 AS AMENDED) MUST CONTACT ALL UTILITY COMPANIES BEFORE EXCAVATING AND DRILLING AND CALL DIGSAFE AT 1(888)DIG-SAFE(7233).

CONSTRUCTION ON THIS LAND IS SUBJECT TO ANY EASEMENTS, RIGHTS-OF-WAY, RESTRICTIONS, RESERVATIONS, OR OTHER LIMITATIONS WHICH MAY BE REVEALED BY AN EXAMINATION OF THE TITLE.

OWNER  
 NORFOLK COUNTY DEVELOPMENT LLC  
 185 QUINCY SHORE DRIVE, #26  
 QUINCY, MA 02171

DEED BOOK 33300 PAGE 92  
 PLAN NO. 40 OF 2014 PLAN BK. 628  
 A.M. 270 LOT 29.2

APPLICANT  
 FRANKLIN LEARNING RE LLC.  
 ATTN: MANOJ GANDHI  
 206 GREAT ROAD  
 LITTLETON, MA. 01460

**SITE PLAN MODIFICATION**  
**505 WEST CENTRAL STREET**  
**LOT 3**  
**(515 WEST CENTRAL STREET)**  
**FRANKLIN**  
**MASSACHUSETTS**

**PHOTOMETRIC PLAN**

**OCTOBER 21, 2020**

DATE	REVISION DESCRIPTION
12/22/2020	PER TOWN COMMENTS
4/8/21	PER TOWN COMMENTS & REQUESTS
4/15/21	REVISED PARKING LAYOUT

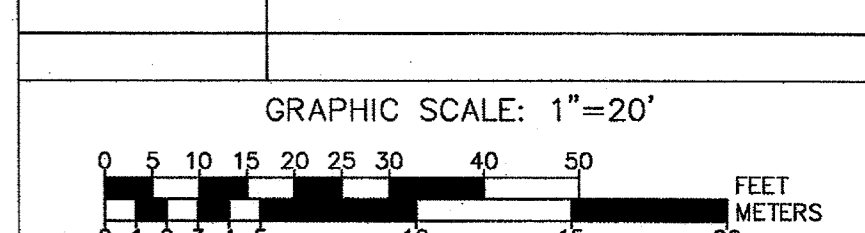

**Guerriere & Halnon, Inc.**  
 ENGINEERING & LAND SURVEYING  
 55 WEST CENTRAL ST. PH. (508) 528-3221  
 FRANKLIN, MA 02038 FX. (508) 528-7921  
 www.gandhengineering.com

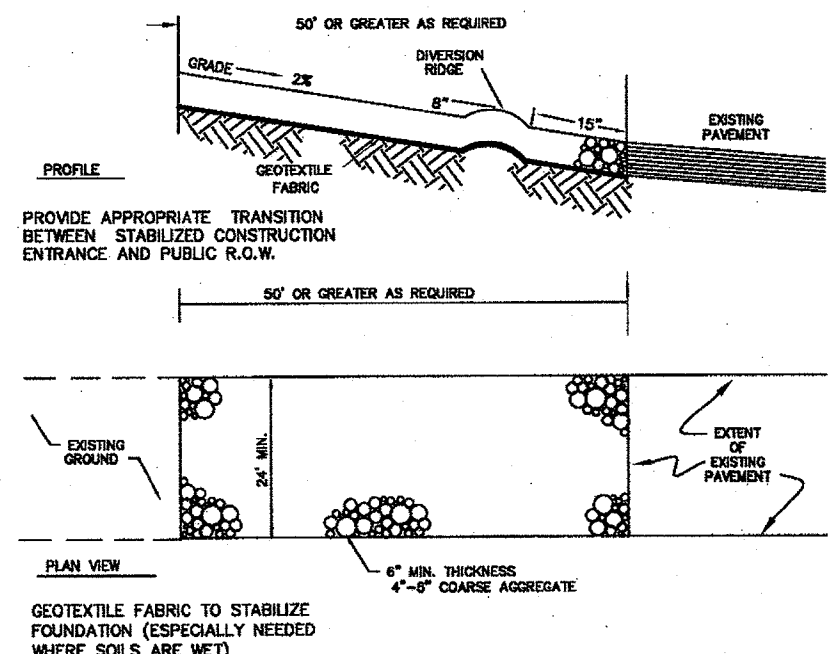

**STABILIZED CONSTRUCTION ENTRANCE**  
NOT TO SCALE

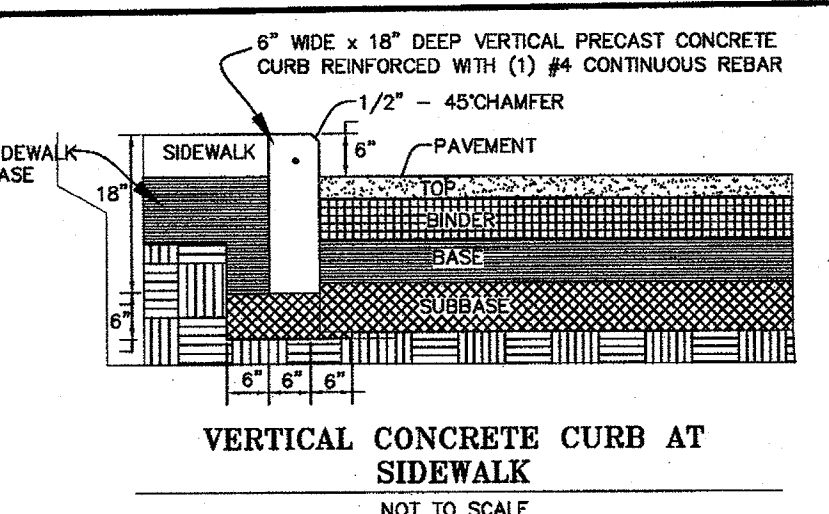

**VERTICAL CONCRETE CURB AT SIDEWALK**  
NOT TO SCALE

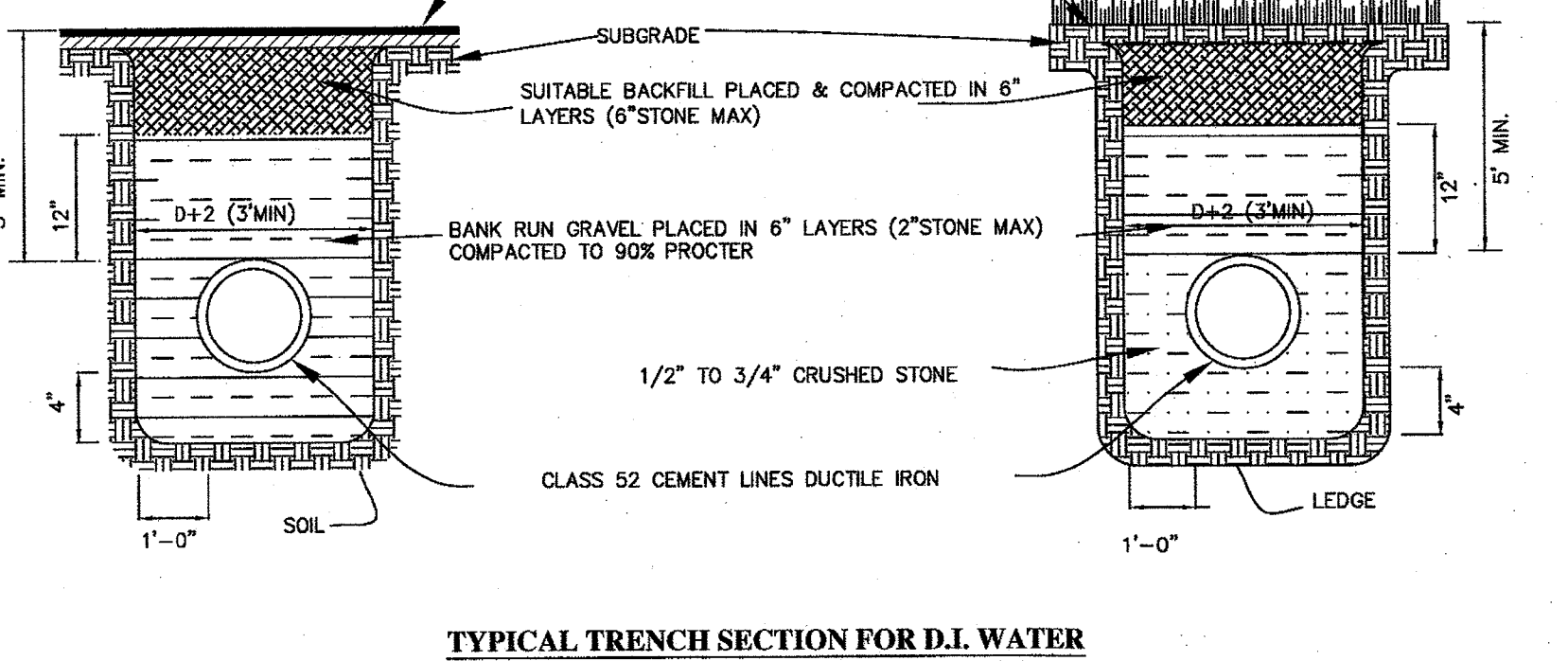

**TYPICAL TRENCH SECTION FOR D.I. WATER MAIN (TYPE 5 BEDDING AWWAC-600)**

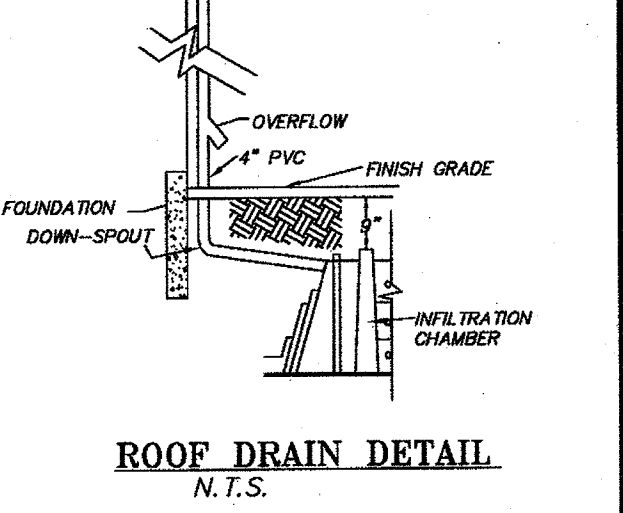

**ROOF DRAIN DETAIL**  
N.T.S.

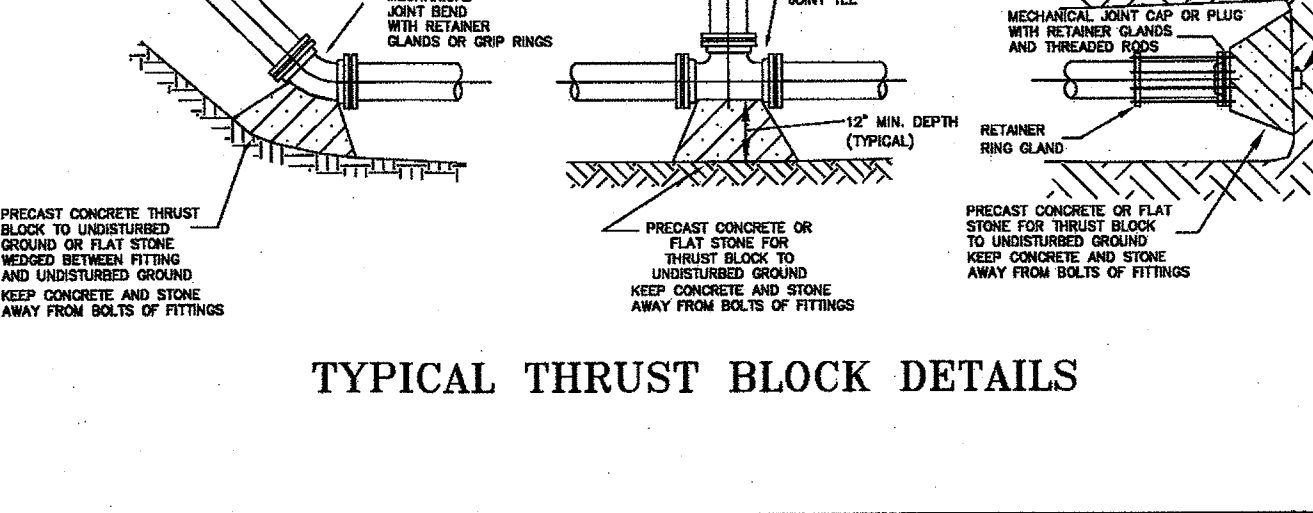

**TYPICAL THRUST BLOCK DETAILS**

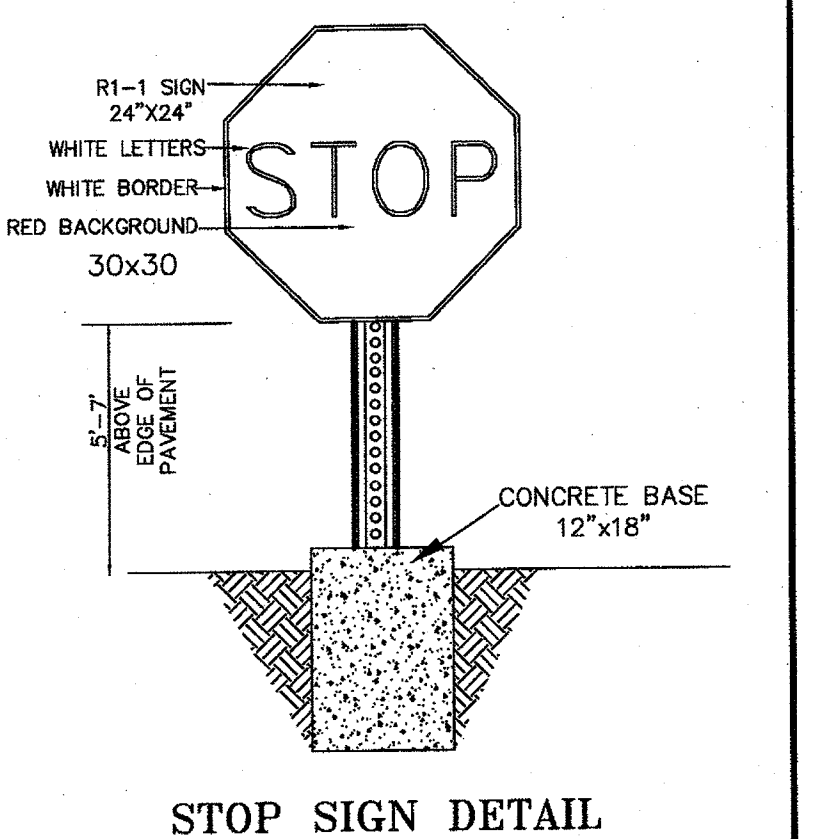

**STOP SIGN DETAIL**

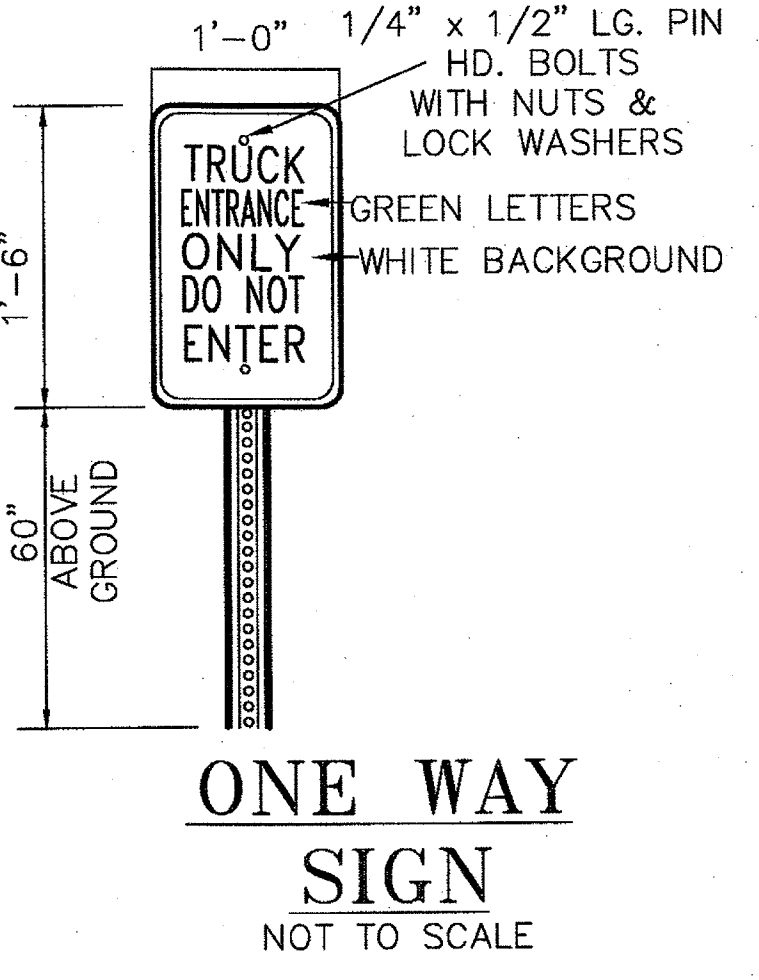

**ONE WAY SIGN**  
NOT TO SCALE

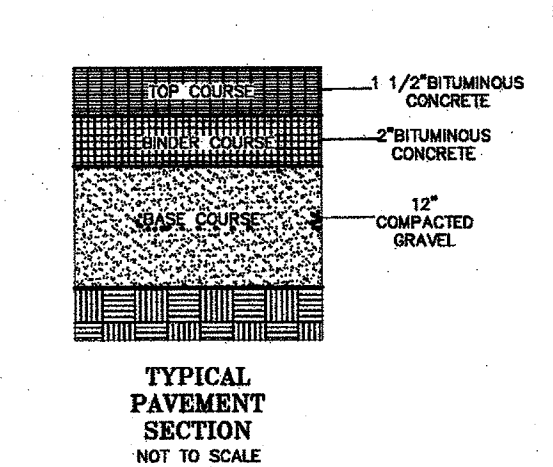

**TYPICAL PAVEMENT SECTION**  
NOT TO SCALE

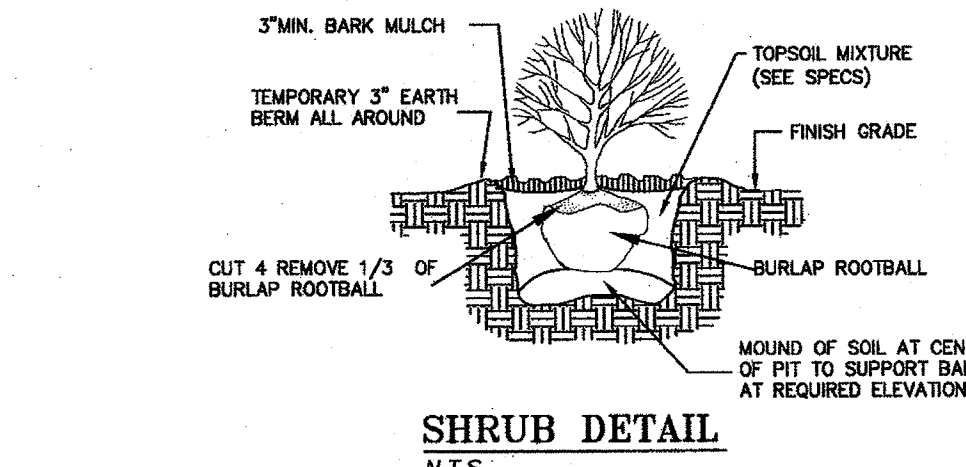

**SHRUB DETAIL**  
N.T.S.

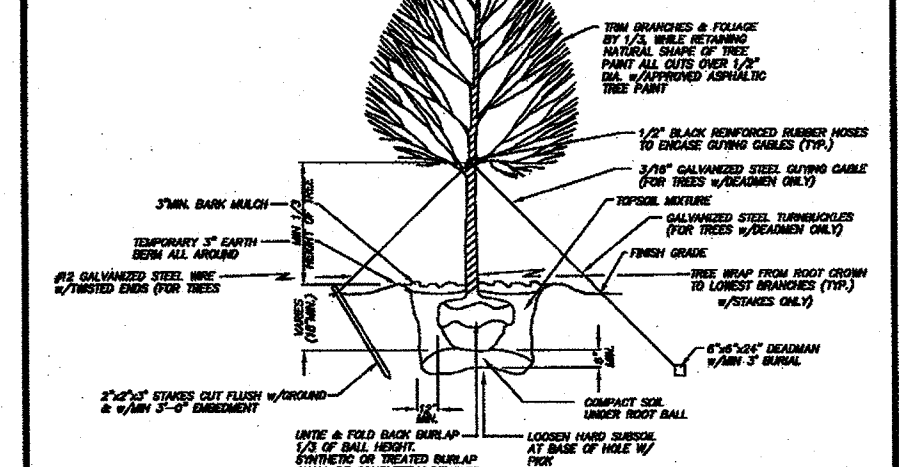

**SPECIMEN DECIDUOUS TREE PLANTING DETAIL**

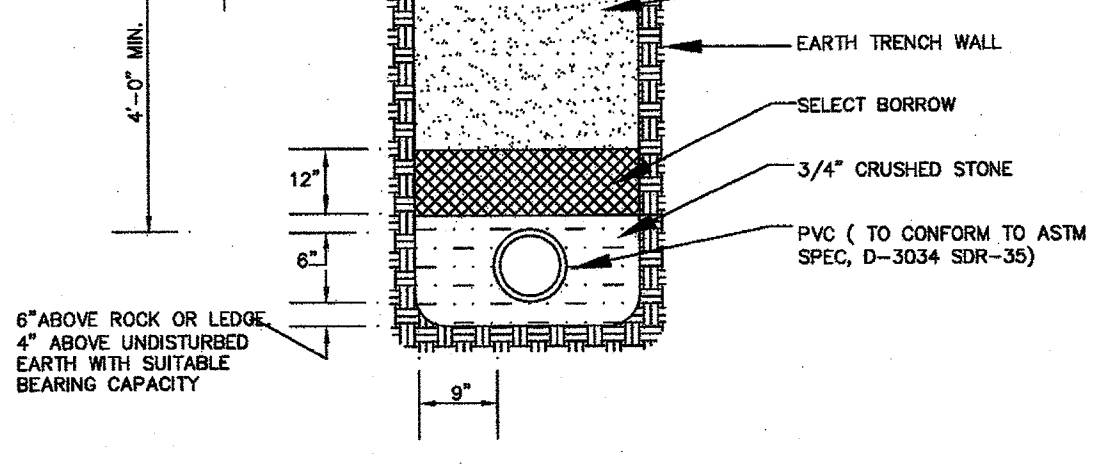

**TYPICAL P.V.C. TRENCH SECTION**  
NOT TO SCALE

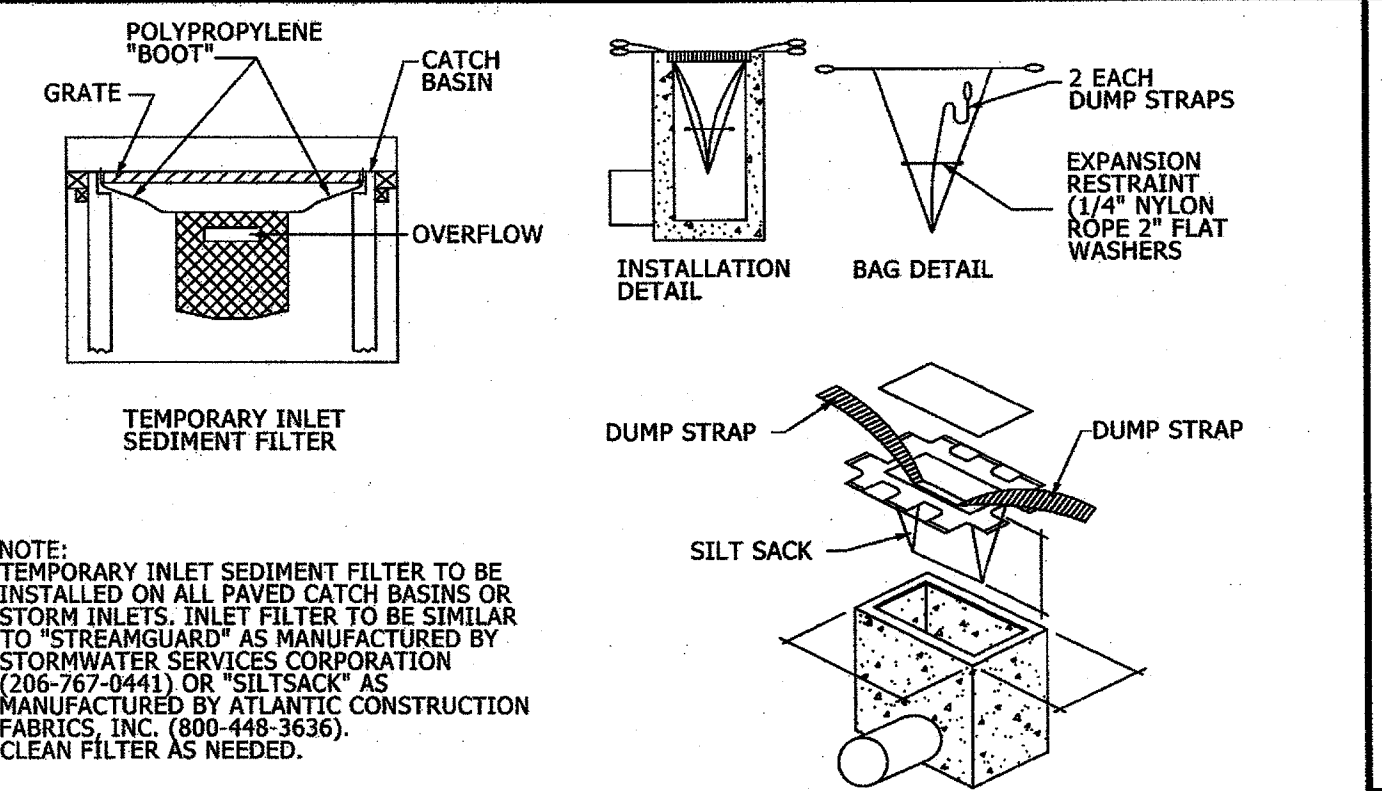

**SILT SACK DETAIL**  
NO SCALE

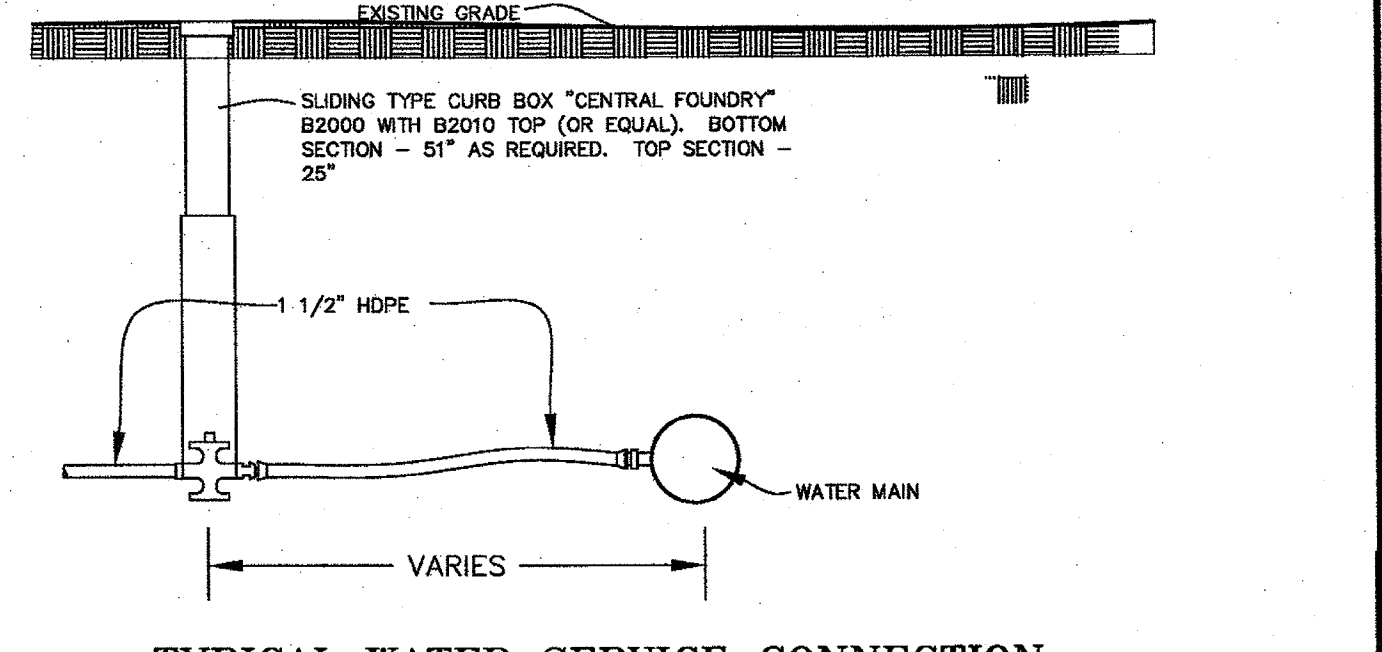

**TYPICAL WATER SERVICE CONNECTION**  
NOT TO SCALE

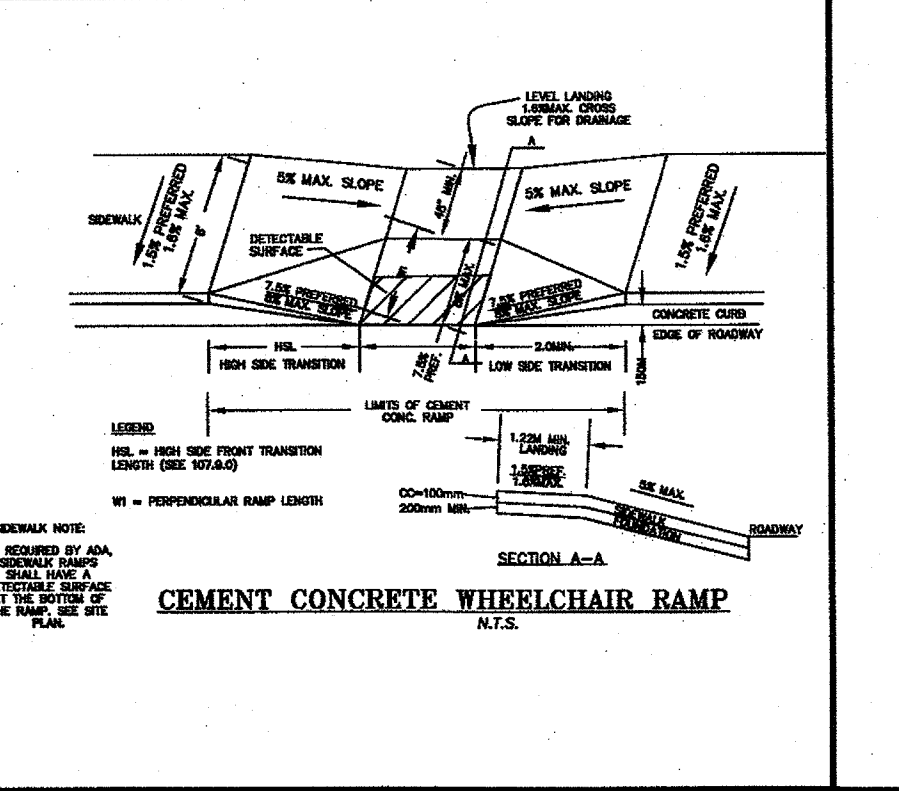

**CEMENT CONCRETE WHEELCHAIR RAMP**  
N.T.S.

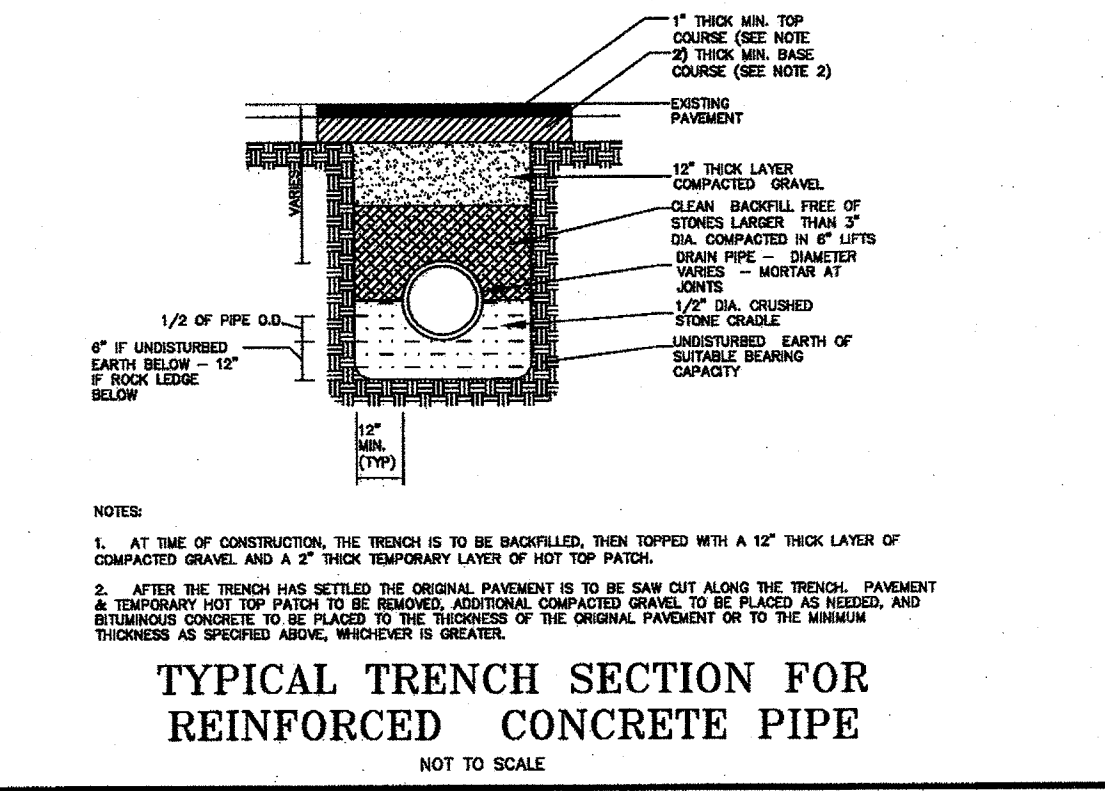

**TYPICAL TRENCH SECTION FOR REINFORCED CONCRETE PIPE**  
NOT TO SCALE

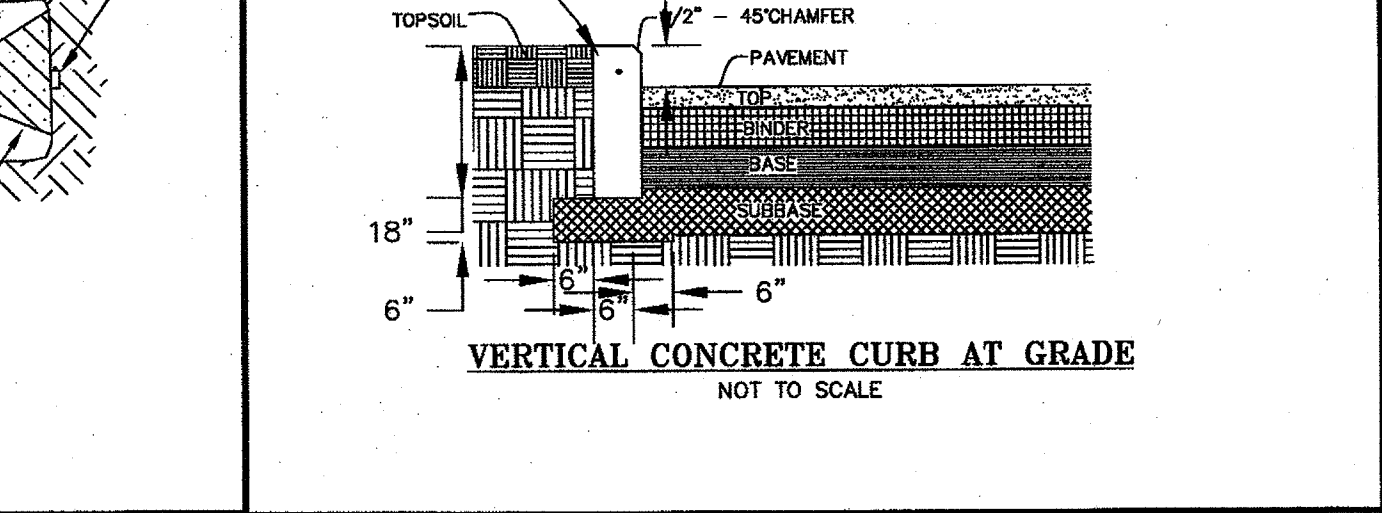

**VERTICAL CONCRETE CURB AT GRADE**  
NOT TO SCALE

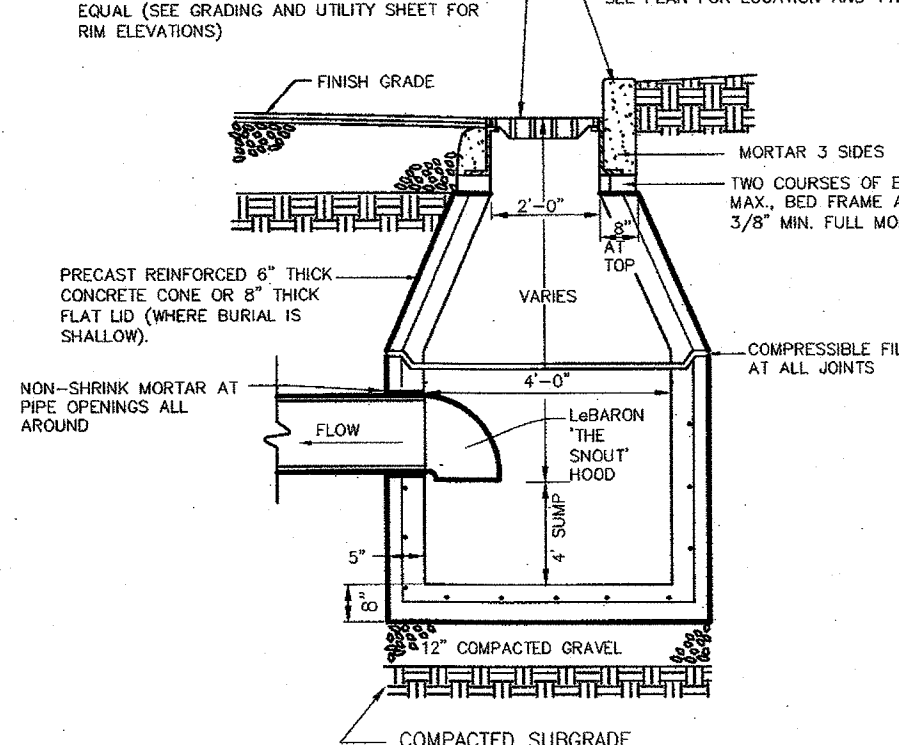

**TYP. PRECAST CONCRETE CATCH BASIN DETAIL**  
NOT TO SCALE

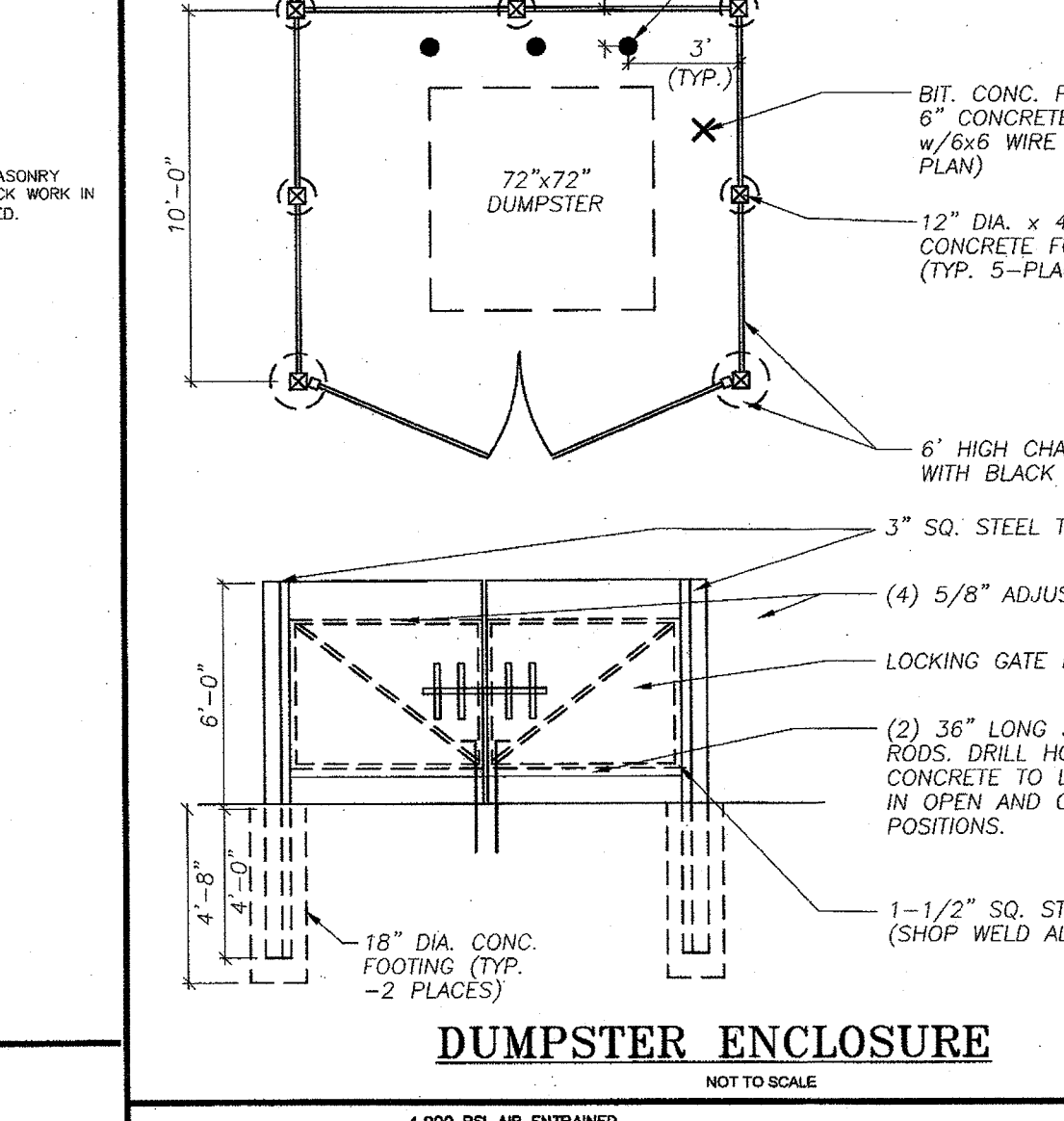

**DUMPSTER ENCLOSURE**  
NOT TO SCALE

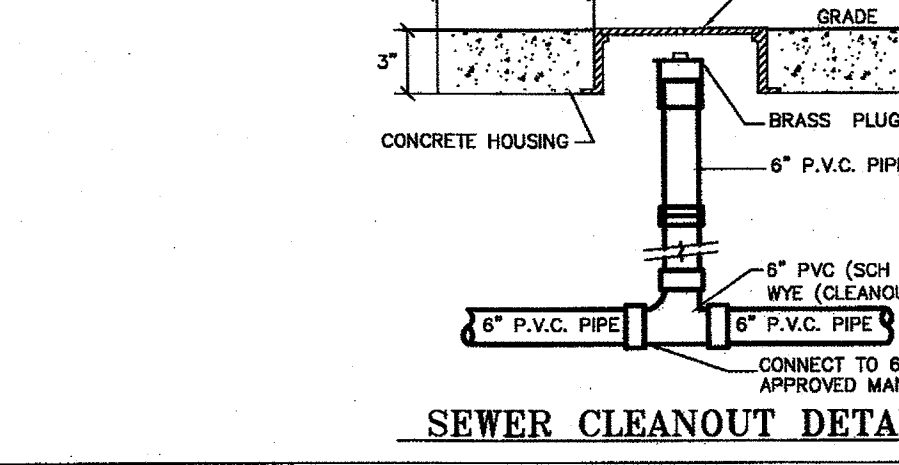

**SEWER CLEANOUT DETAIL**

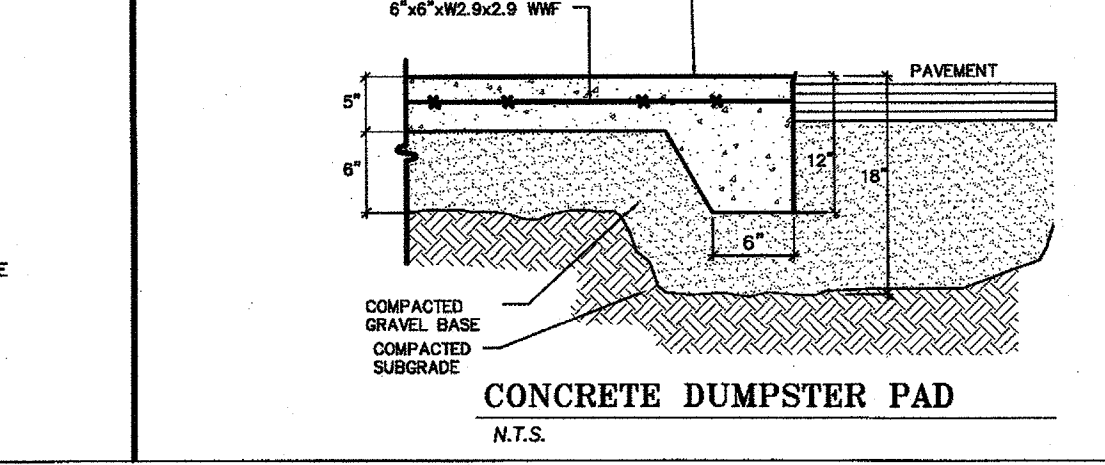

**CONCRETE DUMPSTER PAD**  
N.T.S.

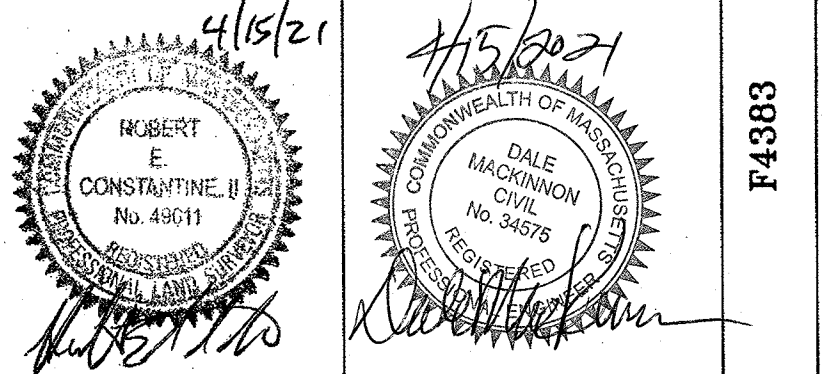

APPROVED DATE:  
FRANKLIN PLANNING BOARD

LEGAL NOTES  
UTILITIES ARE PLOTTED AS A COMPILATION OF RECORD DOCUMENTS, MARKINGS AND OTHER OBSERVED EVIDENCE TO DEVELOP A VIEW OF THE UNDERGROUND UTILITIES AND SHOULD BE CONSIDERED APPROXIMATE. EXCAVATION OF UNDERGROUND FEATURES CANNOT BE ACCURATELY, COMPLETELY AND RELIABLY DEPICTED. ADDITIONAL UTILITIES, NOT EVIDENCED BY RECORD DOCUMENTS OR OBSERVED PHYSICAL EVIDENCE, MAY EXIST. CONTRACTORS (IN ACCORDANCE WITH MASS.G.L. CHAPTER 82 SECTION 40 AS AMENDED) MUST CONTACT ALL UTILITY COMPANIES BEFORE EXCAVATING AND DRILLING AND CALL DIGSAFE AT 1(888)DIG-SAFE[7233].

CONSTRUCTION ON THIS LAND IS SUBJECT TO ANY EASEMENTS, RIGHTS-OF-WAY, RESTRICTIONS, RESERVATIONS, OR OTHER LIMITATIONS WHICH MAY BE REVEALED BY AN EXAMINATION OF THE TITLE.

OWNER  
NORFOLK COUNTY DEVELOPMENT LLC  
185 QUINCY SHORE DRIVE, #26  
QUINCY, MA 02171

DEED BOOK 33300 PAGE 92  
PLAN NO. 40 OF 2014 PLAN BK. 628  
A.M. 270 TOL 29.2

APPLICANT  
FRANKLIN LEARNING RE LLC.  
ATTN: MANOJ GANDHI  
205 GREAT ROAD  
LITTLETON, MA. 01460

**SITE PLAN MODIFICATION**  
**505 WEST CENTRAL STREET**  
**LOT 3**  
**(515 WEST CENTRAL STREET)**  
**FRANKLIN**  
**MASSACHUSETTS**  
**CONSTRUCTION**  
**DETAILS**

DATE	REVISION DESCRIPTION
12/22/2020	PER TOWN COMMENTS
4/8/21	PER TOWN COMMENTS & REQUESTS
4/15/21	REVISED PARKING LAYOUT

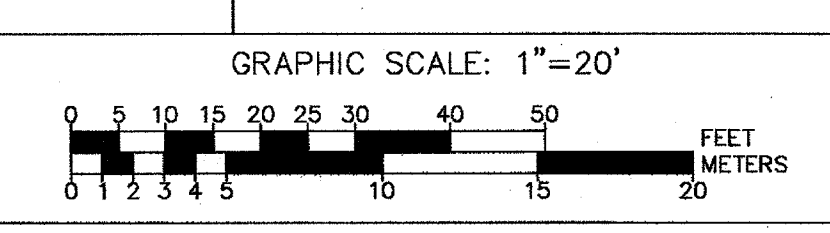

**Guerriere & Halnon, Inc.**  
ENGINEERING & LAND SURVEYING  
55 WEST CENTRAL ST. PH. (508) 528-3221  
FRANKLIN, MA 02038 FX. (508) 528-7921  
www.gandhiengineering.com



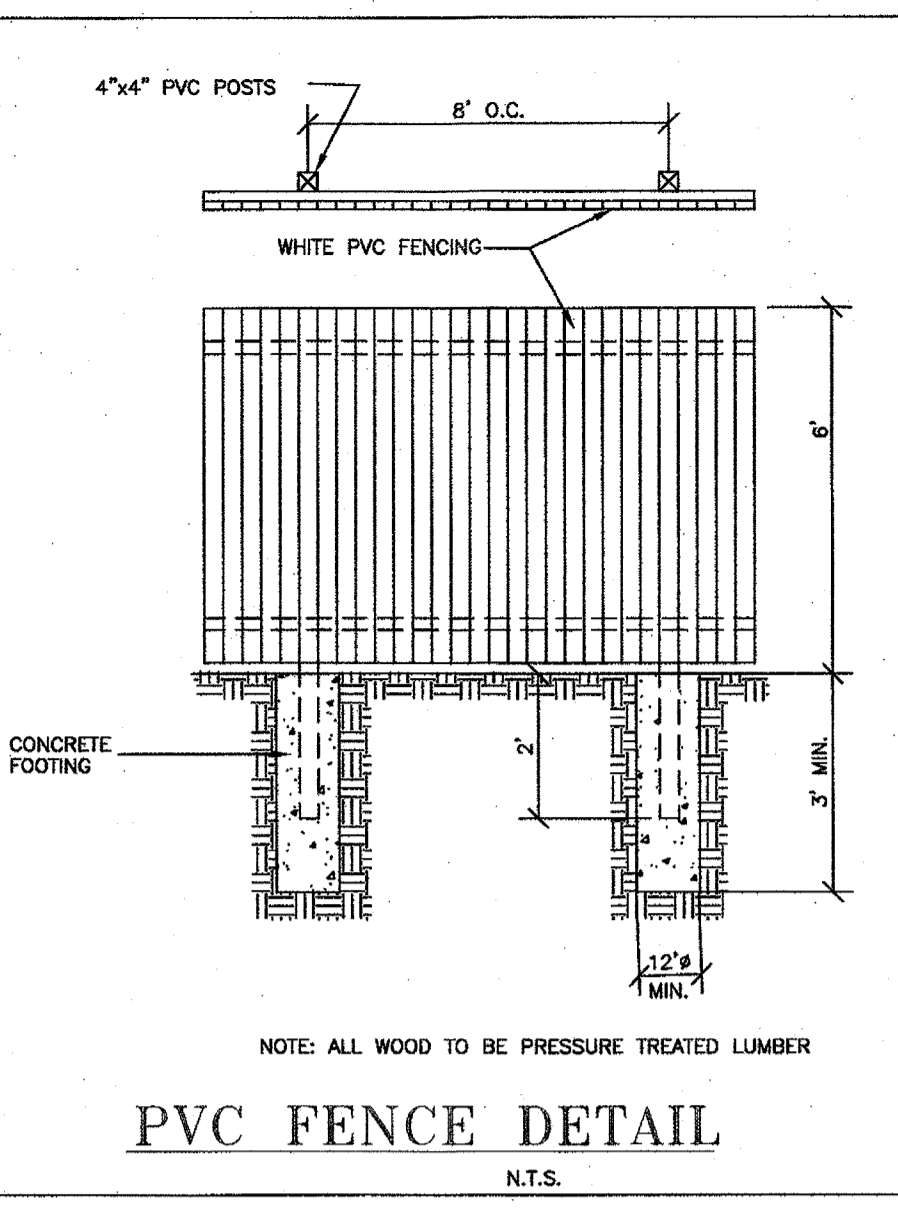
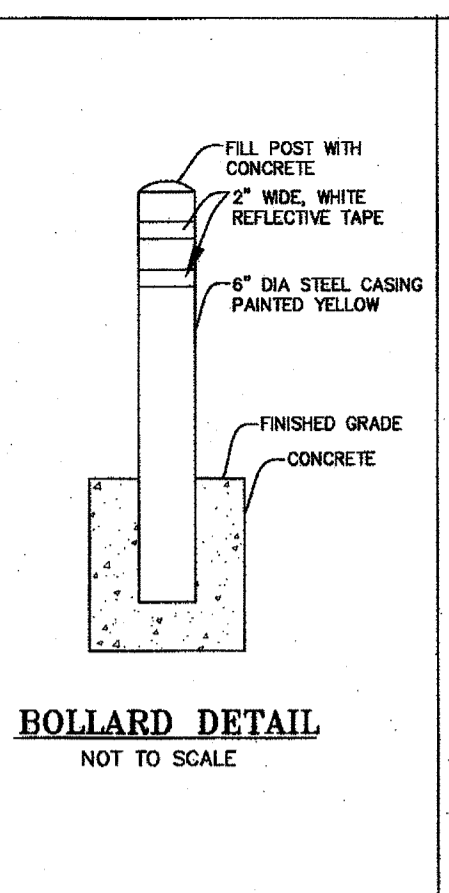
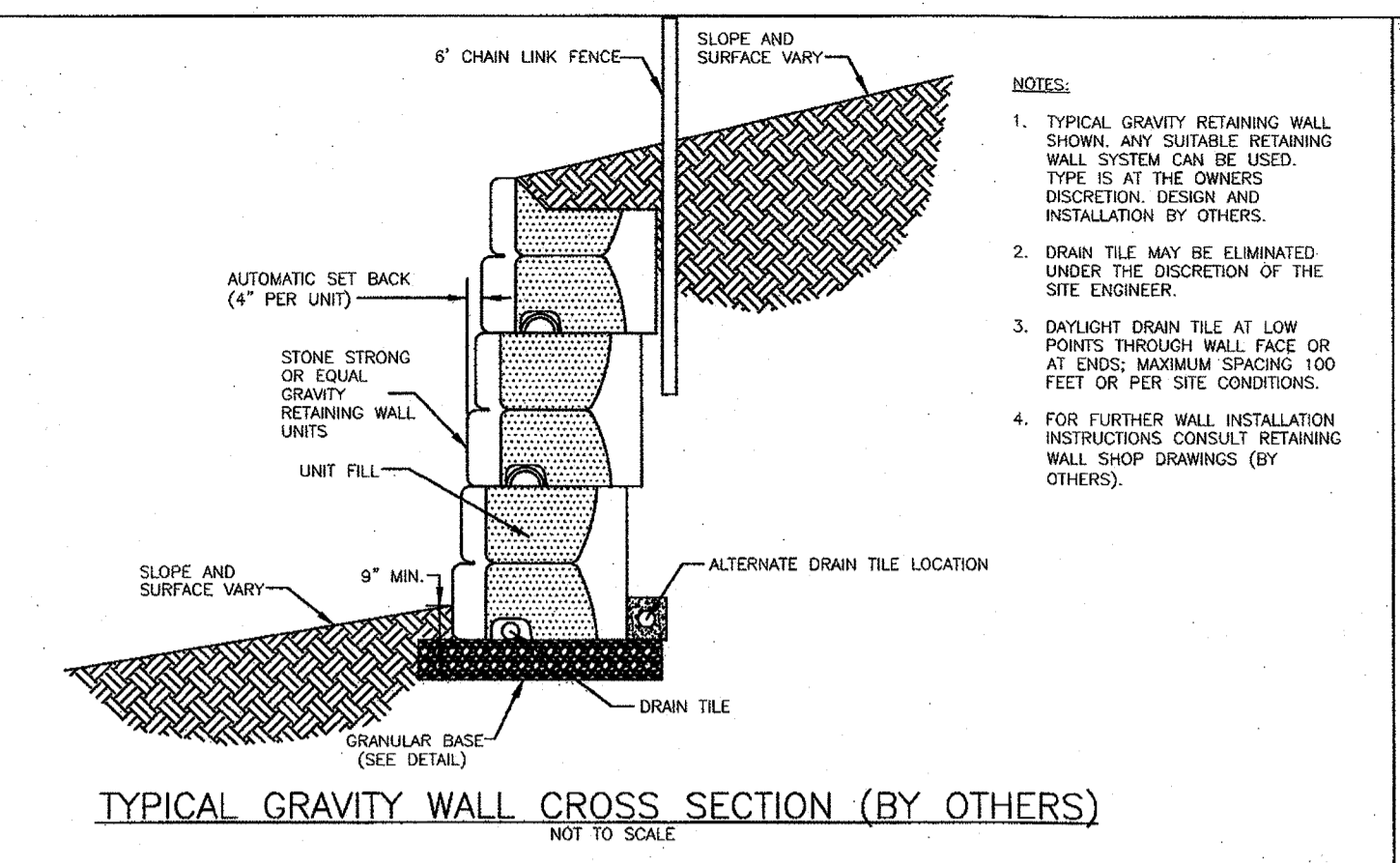
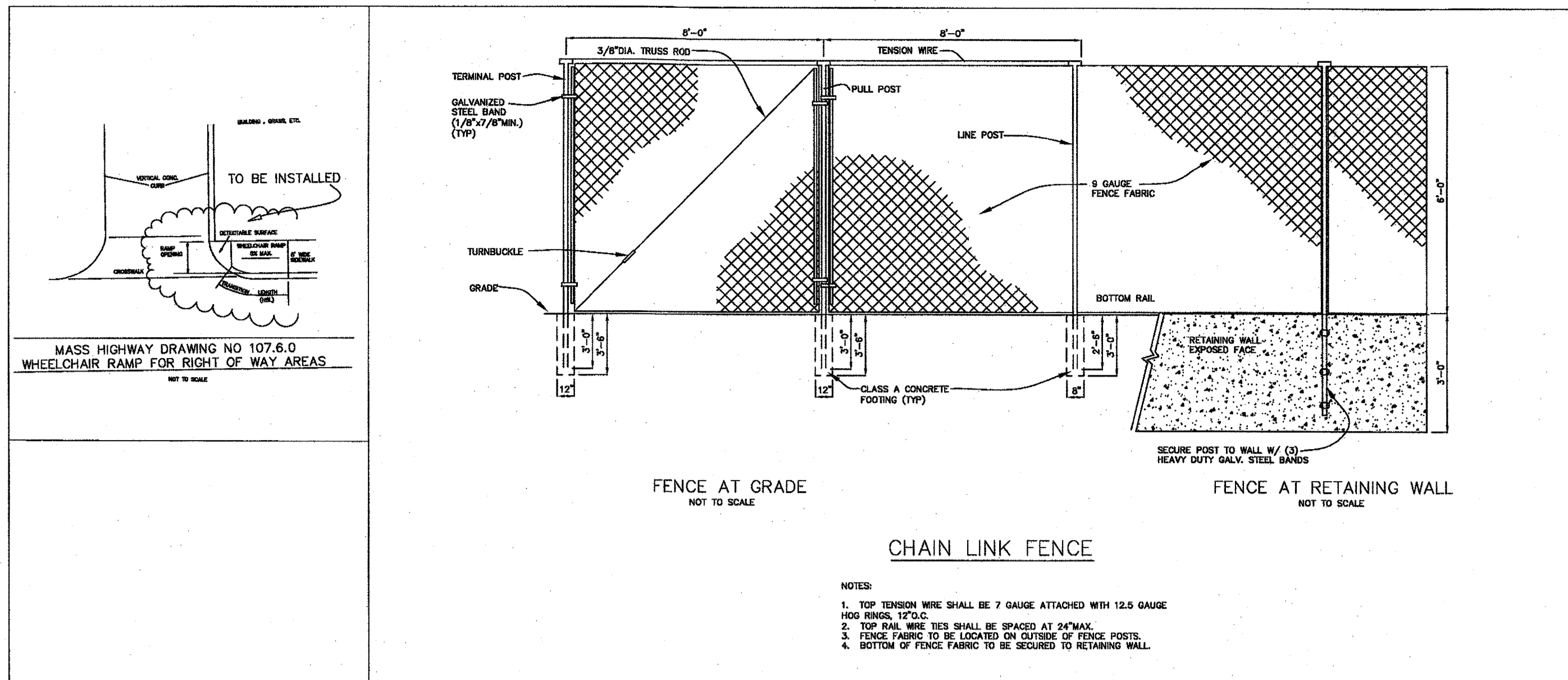

APPROVED DATE: \_\_\_\_\_

FRANKLIN PLANNING BOARD

\_\_\_\_\_

\_\_\_\_\_

\_\_\_\_\_

\_\_\_\_\_

BEING A MAJORITY

LEGAL NOTES

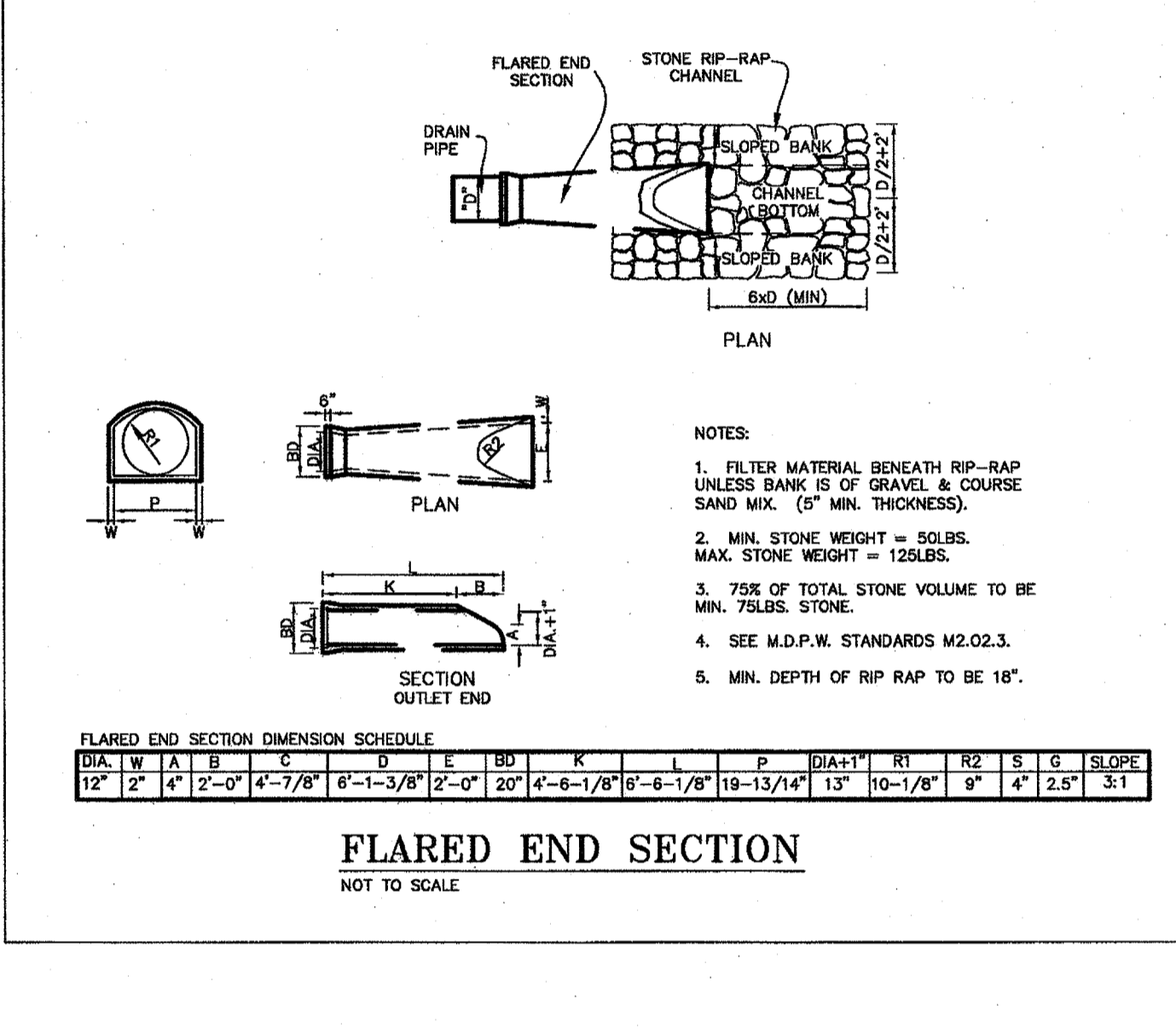
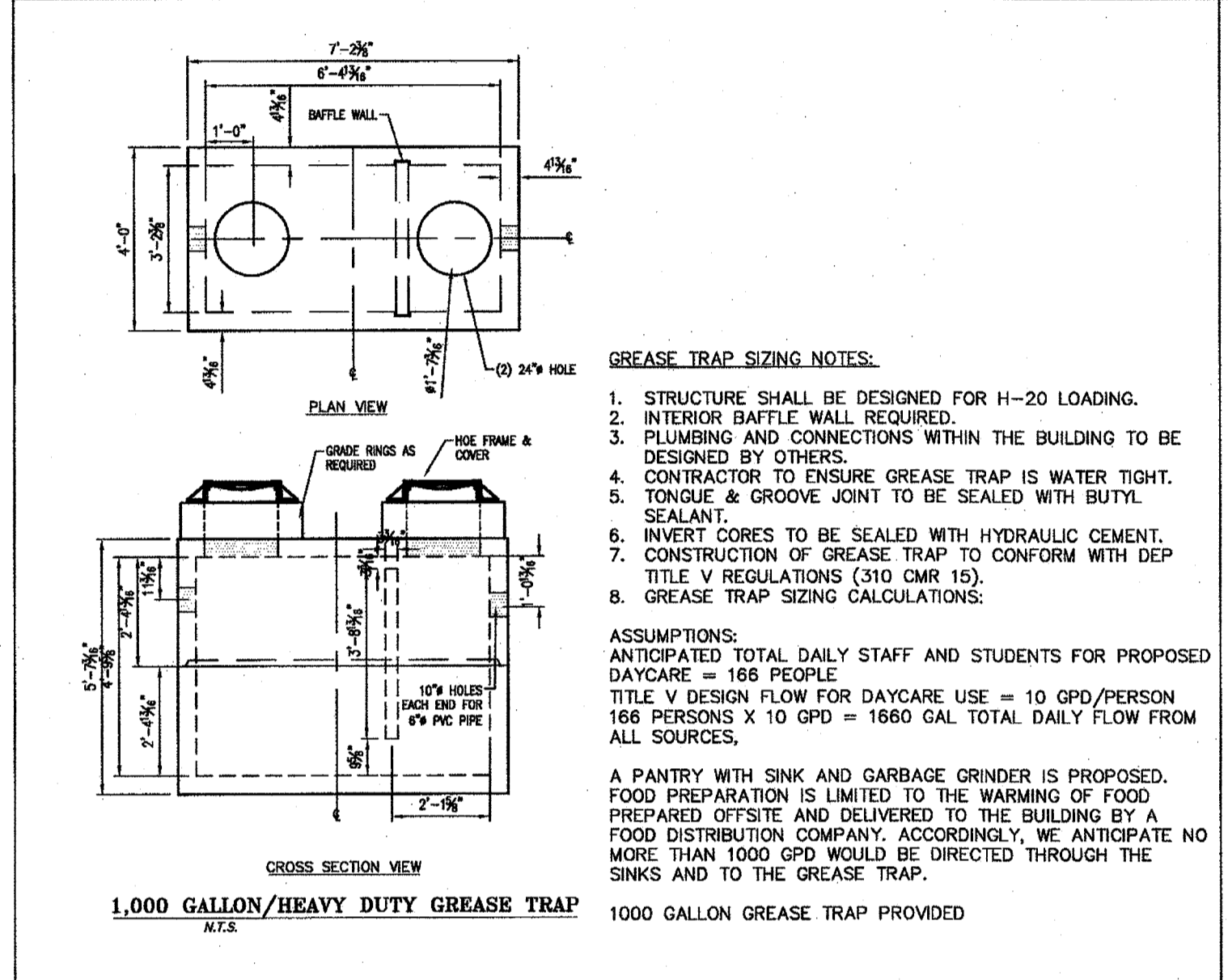

UTILITIES ARE PLOTTED AS A COMPILATION OF RECORD DOCUMENTS, MARKINGS AND OTHER OBSERVED EVIDENCE TO DEVELOP A VIEW OF THE UNDERGROUND UTILITIES AND SHOULD BE CONSIDERED APPROXIMATE. EXCAVATION, THE EXACT LOCATION OF UNDERGROUND FEATURES CANNOT BE ACCURATELY, COMPLETELY AND RELIABLY DEPICTED. ADDITIONAL UTILITIES, NOT EVIDENCED BY RECORD DOCUMENTS OR OBSERVED PHYSICAL EVIDENCE, MAY EXIST. CONTRACTORS (IN ACCORDANCE WITH MASS.G.L. CHAPTER 82 SECTION 40 AS AMENDED) MUST CONTACT ALL UTILITY COMPANIES BEFORE EXCAVATING AND DRILLING AND CALL DIGSAFE AT 1(888)DIG-SAFE(7233).

CONSTRUCTION ON THIS LAND IS SUBJECT TO ANY EASEMENTS, RIGHTS-OF-WAY, RESTRICTIONS, RESERVATIONS, OR OTHER LIMITATIONS WHICH MAY BE REVEALED BY AN EXAMINATION OF THE TITLE.

OWNER

NORFOLK COUNTY DEVELOPMENT LLC  
185 QUINCY SHORE DRIVE, #26  
QUINCY, MA 02171

DEED BOOK 33300 PAGE 92  
PLAN NO. 40 OF 2014 PLAN BK. 628  
A.M. 270 LOT 29.2

APPLICANT

FRANKLIN LEARNING RE LLC.  
ATTN: MANOJ GANDHI  
206 GREAT ROAD  
LITTLETON, MA. 01460

**SITE PLAN MODIFICATION**  
**505 WEST CENTRAL STREET**  
**LOT 3**  
**(515 WEST CENTRAL STREET)**  
**FRANKLIN**  
**MASSACHUSETTS**  
**CONSTRUCTION**  
**DETAILS**

**OCTOBER 21, 2020**

DATE	REVISION DESCRIPTION
12/22/2020	PER TOWN COMMENTS
4/8/21	PER TOWN COMMENTS & REQUESTS
4/15/21	REVISED PARKING LAYOUT

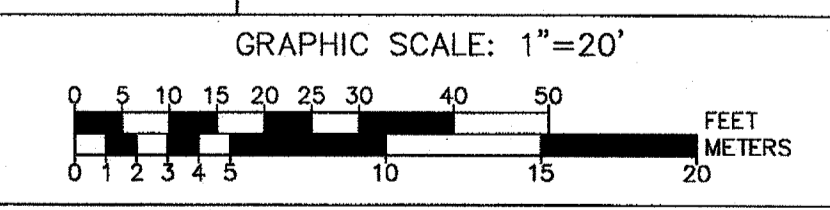

**Guerriere & Halnon, Inc.**  
ENGINEERING & LAND SURVEYING

55 WEST CENTRAL ST. PH. (508) 528-3221  
FRANKLIN, MA 02038 FX. (508) 528-7921  
www.gandhengineering.com

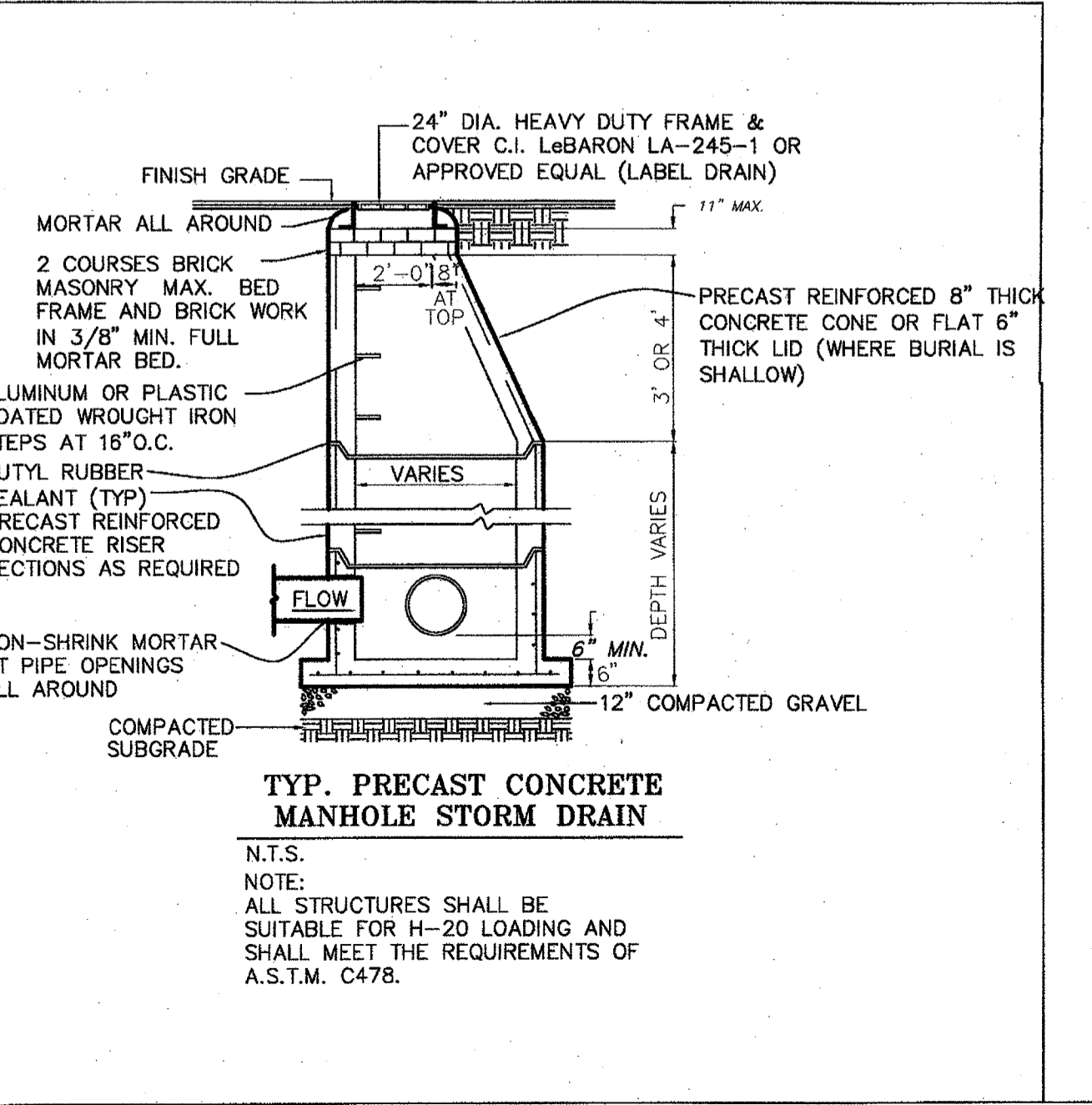
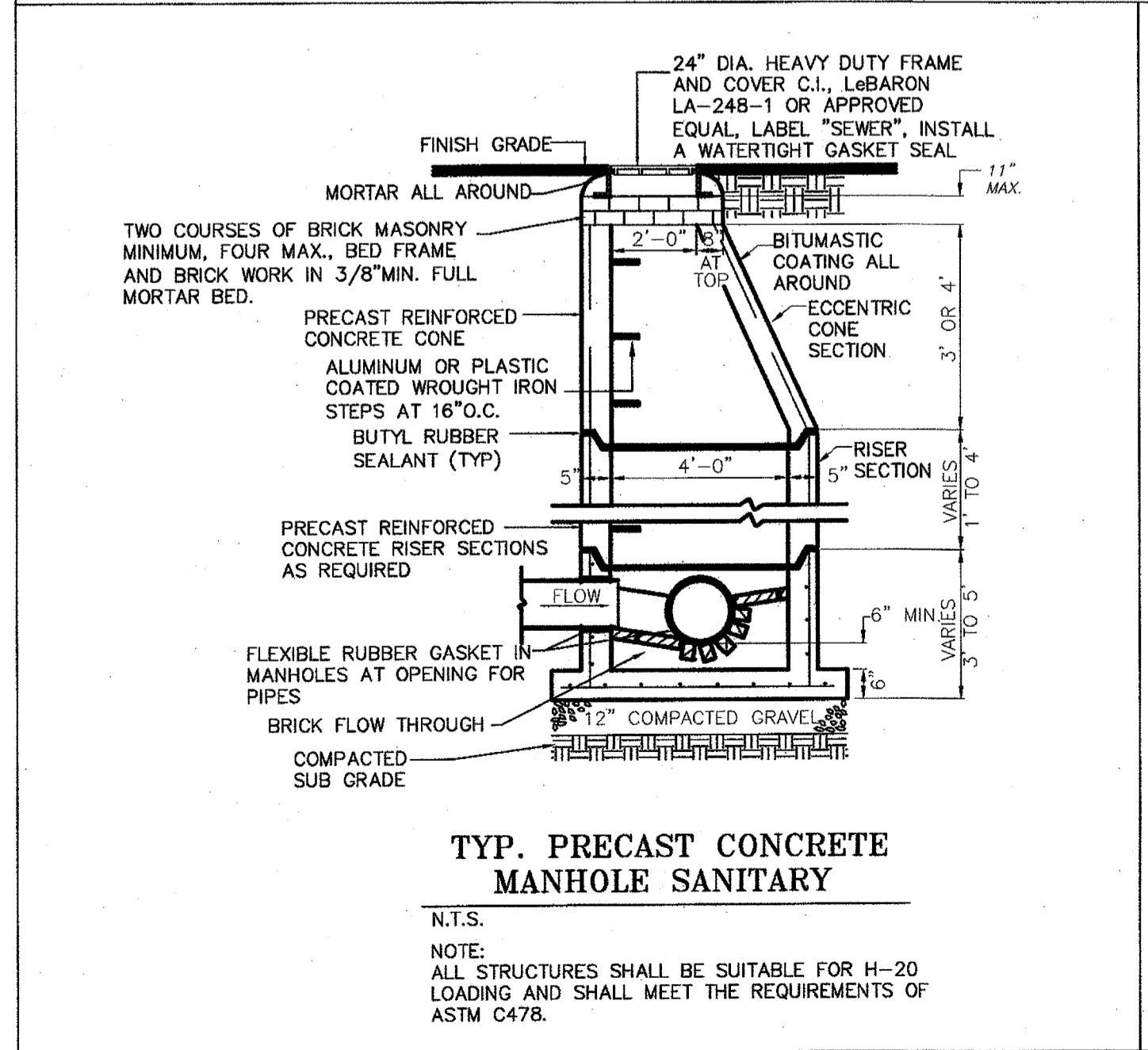

**STORM WATER POLLUTION PREVENTION PLAN (SWPPP)**

**A. NAMES OF PERSONS OR ENTITY RESPONSIBLE FOR PLAN COMPLIANCE**

APPLICANT: MANOJ GANDHI  
FRANKLIN LEARNING RE, LLC  
206 GREAT ROAD  
LITTLETON, MA. 01460

**B. CONSTRUCTION PERIOD POLLUTION PREVENTION MEASURES**

1. INVENTORY MATERIALS TO BE PRESENT ON SITE DURING CONSTRUCTION.
2. TRAIN EMPLOYEES AND SUBCONTRACTORS IN PREVENTION AND CLEAN UP PROCEDURES.
3. ALL MATERIALS STORED ON SITE WILL BE STORED IN THEIR APPROPRIATE CONTAINERS AND IF POSSIBLE UNDER A ROOF OR COVERED.
4. FOLLOW MANUFACTURER'S RECOMMENDATION FOR DISPOSAL OF USED CONTAINERS.
5. STORE ONLY ENOUGH PRODUCT ON SITE TO DO THE JOB.
6. ON SITE EQUIPMENT, FUELING AND MAINTENANCE MEASURES:
  - a. INSPECT ON-SITE VEHICLES AND EQUIPMENT DAILY FOR LEAKS.
  - b. CONDUCT ALL VEHICLE AND EQUIPMENT MAINTENANCE AND REFUELING IN FRONT OF BUILDING, AWAY FROM STORM DRAINS.
  - c. PERFORM MAJOR REPAIRS AND MAINTENANCE OFF SITE.
  - d. USE DRIP PANS, DRIP CLOTHS OR ABSORBENT PADS WHEN REPLACING SPENT FUELS.
  - e. COLLECT SPENT FUELS AND REMOVE FROM SITE, PER LOCAL AND STATE REGULATIONS.
  - f. MAINTAIN A CLEAN CONSTRUCTION ENTRANCE WHERE TRUCK TRAFFIC IS FREQUENT TO REDUCE SOIL COMPACTION CONSTANT SWEEPING IS REQUIRED AND LIMIT TRACKING OF SEDIMENT INTO STREETS, SWEEPING STREET WHEN SILT IS OBSERVED ON STREET.
7. INSTALL SILT SACKS OR SILTATION BASKETS IN ALL CATCH BASINS ON SITE TO REDUCE SEDIMENT RUNOFF FROM SITE.
8. A TEMPORARY CONCRETE WASHOUT STATION AND EQUIPMENT WASH STATION SHALL BE LOCATED ON THE SITE. CONCRETE WASHOUT STATION AND EQUIPMENT WASH STATION SHALL NOT BE WITHIN THE 100' WETLAND BUFFER OR THE 200' RIVERFRONT AREA. AREAS SHALL BE SURROUNDED WITH A SILT FENCE/HAY BALE COMBINATION TO CONTAIN MATERIALS AND PROVIDE EASE OF CLEANUP.
9. STOCK PILE MATERIALS, AND MAINTAIN EROSION CONTROL AROUND THE MATERIALS WHERE IT CAN EASILY BE ACCESSED. MAINTAIN EASY ACCESS TO CLEAN UP MATERIALS TO INCLUDE BROOMS, MOPS, RAGS GLOVES, GOGGLES, SAND, SAWDUST, PLASTIC AND METAL TRASH CONTAINERS.
10. CLEAN UP SPILLS.
  - a. NEVER HOSE DOWN "DIRTY" PAVEMENT OR IMPERMEABLE SURFACES WHERE FLUIDS HAVE SPILLED. USE DRY CLEAN UP METHODS (SAWDUST, CAT LITTER AND/OR RAGS AND ABSORBENT PADS).
  - b. SWEEP UP DRY MATERIALS IMMEDIATELY. NEVER WASH THEM AWAY OR BURY THEM.
  - c. CLEAN UP SPILLS ON DIRT AREAS BY DIGGING UP AND PROPERLY DISPOSING OF CONTAMINATED SOIL IN A CERTIFIED CONTAINER AND NOTIFY A CERTIFIED HAULER FOR REMOVAL.
  - d. REPORT SIGNIFICANT SPILLS TO THE FIRE DEPARTMENT.
11. IT IS THE RESPONSIBILITY OF THE SITE SUPERINTENDENT OR EMPLOYEES DESIGNATED BY THE APPLICANT TO INSPECT EROSION CONTROL AND REPAIR AS NEEDED, ALSO TO INSPECT ALL ON SITE VEHICLES FOR LEAKS AND CHECK ALL CONTAINERS ON SITE THAT MAY CONTAIN HAZARDOUS MATERIALS DAILY.

**C. SITE DEVELOPMENT PLANS**

1. SEE PLAN ENTITLED "SITE PLAN 515 WEST CENTRAL STREET, FRANKLIN, MA" DATED OCTOBER 21, 2020 PREPARED BY GUERRIERE & HALNON, INC.

**D. CONSTRUCTION EROSION AND SEDIMENTATION CONTROL PLAN;**

1. SEE GRADING AND EROSION CONTROL PLAN WITHIN ABOVE MENTIONED SITE PLANS.

**E. PLANS**

1. CONSTRUCTION SEQUENCING PLAN - ACTUAL SEQUENCE OF CONSTRUCTION ACTIVITIES TO BE DETERMINED BY THE SITE CONTRACTOR.
  - a. RECORD ORDER OF CONDITIONS - THE SITE SUPERINTENDENT SHALL BE AWARE OF ALL THE CONDITIONS CONTAINED WITHIN THE ORDER INCLUDING INSPECTION SCHEDULES.
  - b. INSTALL DEP FILE # SIGN .
  - c. PRIOR TO ANY WORK ON THE SITE INCLUDING TREE/BRUSH CLEARING, THE APPROVED LIMIT OF CLEARING AS WELL AS THE LOCATION OF THE PROPOSED EROSION CONTROL DEVICES (SUCH AS SILT FENCE/STRAW BALES, ETC.) MUST BE STAKED ON THE GROUND UNDER THE DIRECTION OF A MASSACHUSETTS REGISTERED PROFESSIONAL LAND SURVEYOR.
  - d. INSTALL EROSION CONTROL BARRIER AT LOCATIONS DEPICTED ON THE PLANS.
  - e. STRIP OFF TOP AND SUBSOIL. STOCKPILE MATERIAL TO BE REUSED, REMOVE EXCESS MATERIAL FROM THE SITE. INSTALL AND MAINTAIN EROSION CONTROL BARRIER AROUND STOCKPILE.
  - f. ROUGH GRADE SITE, MAINTAINING A TEMPORARY LOW AREA/SEDIMENT TRAP AWAY FROM THE WETLAND (IF PRESENT).
  - g. CONSTRUCT TEMPORARY SEDIMENTATION BASINS IN THE LOCATION OF THE PROPOSED STORMWATER BASINS.
  - h. INSTALL UNDERGROUND UTILITIES; PROTECT ALL OPEN DRAINAGE STRUCTURES WITH EROSION/SILTATION CONTROL DEVICES.
  - i. CONSTRUCT BUILDINGS.
  - j. INSTALL BINDER COURSE OF BITUMINOUS ASPHALT.
  - k. INSTALL WEARING COURSE OF ASPHALT, AND STRIPING (WHERE REQUIRED).
  - l. MAINTAIN ALL EROSION CONTROL DEVICES UNTIL SITE IS STABILIZED AND A CERTIFICATE OF COMPLIANCE (IF REQUIRED) IS ISSUED BY THE CONSERVATION COMMISSION.
  - m. CLEAN OUT SEDIMENT BASINS AND RECONFIGURE FOR INFILTRATION BASINS.
  - n. THE CONTRACTOR SHALL BE RESPONSIBLE TO SCHEDULE ANY REQUIRED INSPECTIONS OF HIS/HER WORK.

**2. CONSTRUCTION WASTE MANAGEMENT PLAN**

- a. DUMPSTER FOR TRASH AND BULK WASTE COLLECTION SHALL BE PROVIDED SEPARATELY FOR CONSTRUCTION.
- b. RECYCLE MATERIALS WHENEVER POSSIBLE (PAPER, PLASTER CARDBOARD, METAL CANS). SEPARATE CONTAINERS FOR MATERIAL ARE RECOMMENDED.
- c. SEGREGATE AND PROVIDE CONTAINERS FOR DISPOSAL OPTIONS FOR WASTE.
- d. DO NOT BURY WASTE AND DEBRIS ON SITE.
- e. CERTIFIED HAULERS WILL BE HIRED TO REMOVE THE DUMPSTER CONTAINER WASTE AS NEEDED. RECYCLING PRODUCTS WILL ALSO BE REMOVED OFF SITE WEEKLY.
- f. THE SEWER SYSTEM IS ONLY FOR DISPOSAL OF HUMAN WASTE, AND SUBSTANCES PERMITTED FOR DISPOSAL BY THE SEWER DEPARTMENT.

**F. OPERATION AND MAINTENANCE OF EROSION AND SEDIMENTATION CONTROLS**

THE OPERATION AND MAINTENANCE OF SEDIMENTATION CONTROL SHALL BE THE RESPONSIBILITY OF THE CONTRACTOR. THE INSPECTION AND MAINTENANCE OF THE STORMWATER COMPONENT SHALL BE PERFORMED AS NOTED BELOW. THE CONTRACTOR SHALL, AT ALL TIMES HAVE EROSION CONTROL IN PLACE. THE CONTRACTOR, BASED ON FUTURE WEATHER REPORTS SHALL PREPARE AND INSPECT ALL EROSION CONTROL DEVICES; CLEANING, REPAIRING AND UPGRADING IS A PRIORITY SO THAT THE DEVICES PERFORM AS PER DESIGN. INSPECT THE SITE DURING RAIN EVENTS. DON'T STAY AWAY FROM THE SITE. AT A MINIMUM, THERE SHOULD BE INSPECTION TO ASSURE THE DEVICES ARE NOT CLOGGED OR PLUGGED, OR THAT DEVICES HAVE NOT BEEN DESTROYED OR DAMAGED DURING THE RAIN EVENT. AFTER A STORM EVENT INSPECTION IS REQUIRED TO CLEAN AND REPAIR ANY DAMAGE COMPONENTS. IMMEDIATE REPAIR IS REQUIRED.

**G. INSPECTION AND MAINTENANCE SCHEDULES**

1. INSPECTION MUST BE CONDUCTED AT LEAST ONCE EVERY 7 DAYS AND WITHIN 24 HOURS OF THE END OF A STORM EVENT 0.5 INCHES OR GREATER.
2. INSPECTION FREQUENCY CAN BE REDUCED TO ONCE A MONTH IF:

- A. THE SITE IS TEMPORARILY STABILIZED.
- B. RUNOFF IS UNLIKELY DUE TO WINTER CONDITIONS, WHEN SITE IS COVERED WITH SNOW OR ICE.
3. INSPECTIONS MUST BE CONDUCTED BY QUALIFIED PERSONNEL, "QUALIFIED PERSONNEL" MEANS A PERSON KNOWLEDGEABLE IN THE PRINCIPLES AND PRACTICE OF EROSION AND SEDIMENT CONTROLS AND WHO POSSESS THE SKILLS TO ASSESS THE CONDITIONS AND TAKE MEASURES TO MAINTAIN AND ENSURE PROPER OPERATION, ALSO TO CONCLUDE IF THE EROSION CONTROL METHODS SELECTED ARE EFFECTIVE.
4. FOR EACH INSPECTION, THE INSPECTION REPORT MUST INCLUDE: (SEE ATTACHED INSPECTION AND MAINTENANCE LOG)
  - g. THE INSPECTION DATE.
  - h. NAMES, TITLES OF PERSONNEL MAKING THE INSPECTION.
  - i. WEATHER INFORMATION FOR THE PERIOD SINCE THE LAST INSPECTION.
  - j. WEATHER INFORMATION AT THE TIME OF THE INSPECTION.
  - k. LOCATIONS OF DISCHARGES OF SEDIMENT FROM THE SITE, IF ANY.
  - l. LOCATIONS OF BMP'S THAT NEED TO BE MAINTAINED.
  - m. LOCATIONS WHERE ADDITIONAL BMP'S MAY BE REQUIRED.
  - n. CORRECTIVE ACTION REQUIRED OR ANY CHANGES TO THE SWPPP THAT MAY BE NECESSARY.

5. QUALIFIED PERSONNEL SHALL INSPECT THE FOLLOWING IN-PLACE WORK;

**INSPECTION SCHEDULE:**

EROSION CONTROL WEEKLY  
CATCH BASINS WEEKLY  
TEMPORARY SEDIMENTATION TRAPS/BASINS WEEKLY  
PAVEMENT SWEEPING WEEKLY

PLEASE NOTE: SPECIAL INSPECTIONS SHALL ALSO BE MADE AFTER A SIGNIFICANT RAINFALL EVENT.

**MAINTENANCE SCHEDULE**

EROSION CONTROL DEVICES FAILURE IMMEDIATELY  
CATCH BASINS SUMP 1/4 FULL OF SEDIMENT  
TEMPORARY SEDIMENTATION TRAPS/BASINS AS NEEDED  
PAVEMENT SWEEPING 14 DAYS MIN. AND PRIOR TO ANY SIGNIFICANT RAIN EVENT.

PLEASE NOTE: SPECIAL MAINTENANCE SHALL ALSO BE MADE AFTER A SIGNIFICANT RAINFALL EVENT.

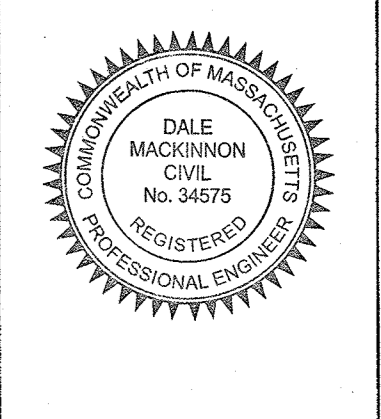
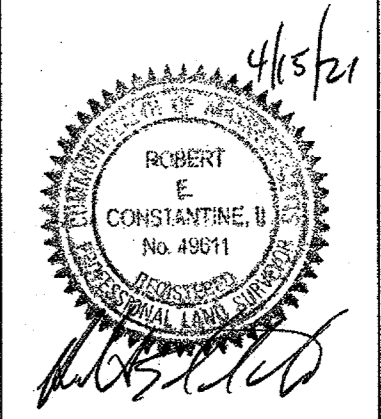

F4383

APPROVED DATE: \_\_\_\_\_  
FRANKLIN PLANNING BOARD  
\_\_\_\_\_  
\_\_\_\_\_  
\_\_\_\_\_  
\_\_\_\_\_  
BEING A MAJORITY

**LEGAL NOTES**

UTILITIES ARE PLOTTED AS A COMPILATION OF RECORD DOCUMENTS, MARKINGS AND OTHER OBSERVED EVIDENCE TO DEVELOP A VIEW OF THE UNDERGROUND UTILITIES AND SHOULD BE CONSIDERED APPROXIMATE. ANY EXCAVATION, THE EXACT LOCATION OF UNDERGROUND FEATURES CANNOT BE ACCURATELY, COMPLETELY, AND RELIABLY DEPICTED. ADDITIONAL UTILITIES, NOT EVIDENCED BY RECORD DOCUMENTS OR OBSERVED PHYSICAL EVIDENCE, MAY EXIST. CONTRACTORS (IN ACCORDANCE WITH MASS.G.L. CHAPTER 82 SECTION 40 AS AMENDED) MUST CONTACT ALL UTILITY COMPANIES BEFORE EXCAVATING AND DRILLING AND CALL DIGSAFE AT 1(888)DIG-SAFE(7233).

CONSTRUCTION ON THIS LAND IS SUBJECT TO ANY EASEMENTS, RIGHTS-OF-WAY, RESTRICTIONS, RESERVATIONS, OR OTHER LIMITATIONS WHICH MAY BE REVEALED BY AN EXAMINATION OF THE TITLE.

**OWNER**

NORFOLK COUNTY DEVELOPMENT LLC  
185 QUINCY SHORE DRIVE, #26  
QUINCY, MA 02171  
  
DEED BOOK 33300 PAGE 92  
PLAN NO. 40 OF 2014 PLAN BK. 628  
A.M. 270 LOT 29.2

**APPLICANT**

FRANKLIN LEARNING RE LLC.  
ATTN: MANOJ GANDHI  
206 GREAT ROAD  
LITTLETON, MA. 01460

**SITE PLAN MODIFICATION**  
**505 WEST CENTRAL STREET**  
**LOT 3**  
**(515 WEST CENTRAL STREET)**  
**FRANKLIN**  
**MASSACHUSETTS**

**CONSTRUCTION**  
**DETAILS**

**OCTOBER 21, 2020**

DATE	REVISION DESCRIPTION
12/22/2020	PER TOWN COMMENTS
4/8/21	PER TOWN COMMENTS & REQUESTS
4/15/21	REVISED PARKING LAYOUT

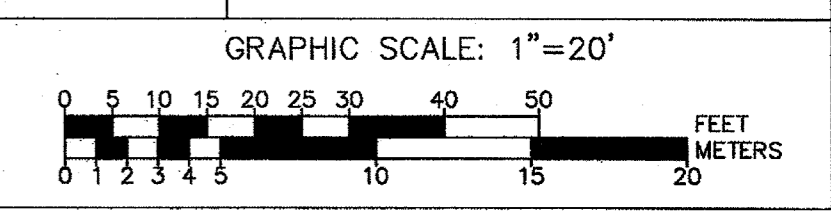

**Guerriere & Halnon, Inc.**  
ENGINEERING & LAND SURVEYING  
55 WEST CENTRAL ST. PH. (508) 528-3221  
FRANKLIN, MA 02038 FX. (508) 528-7921  
www.gandhengineering.com

D:\C:\3D\Format\F4383\DWG\F4383-DETAILS.dwg, 4/15/2021, 9:42:11 AM, DAG